

Make the invisible visible – early on

ZEISS X-Ray Series for light metal casting

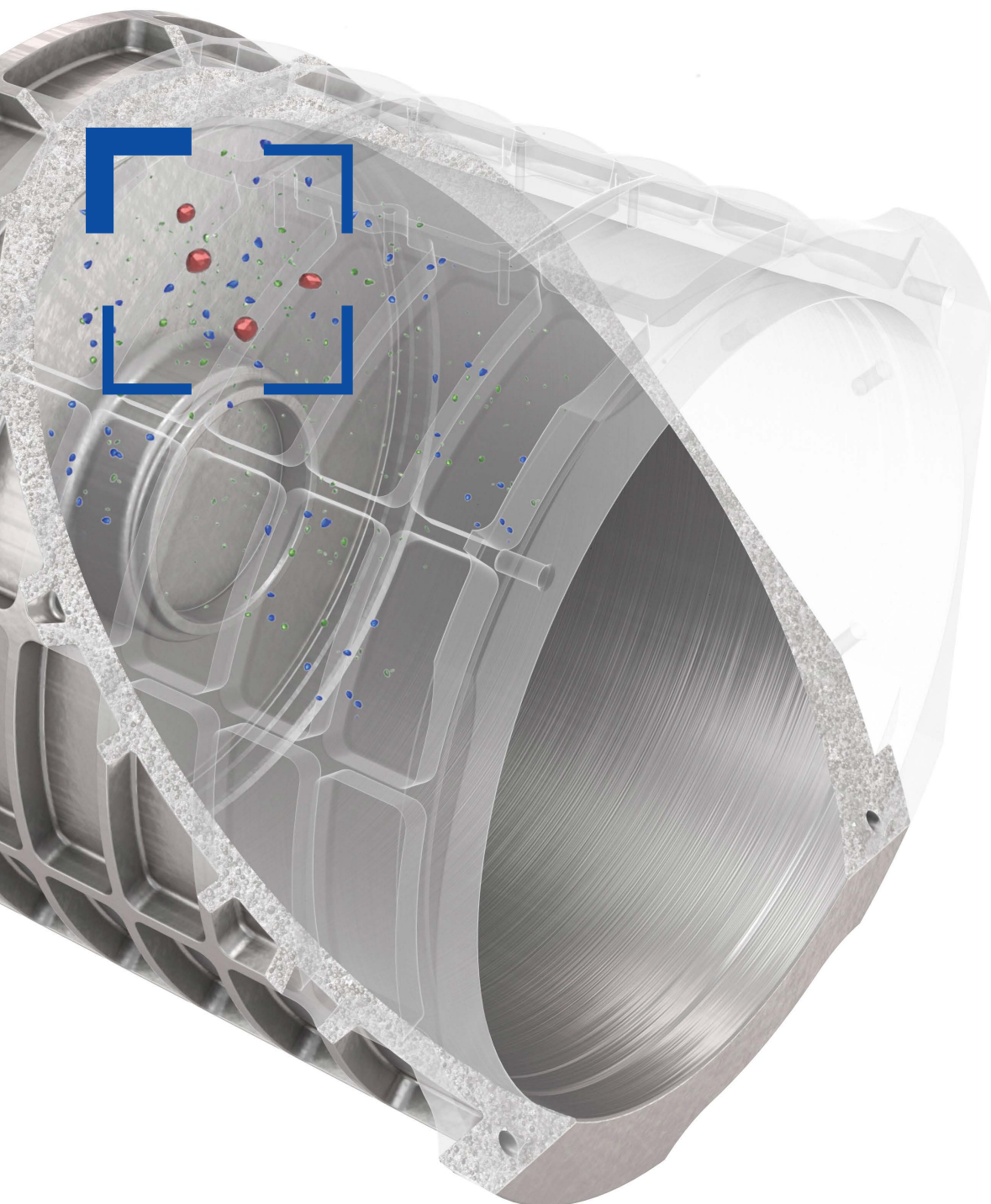

Seeing beyond

Only one casting gets an OK for further processing.

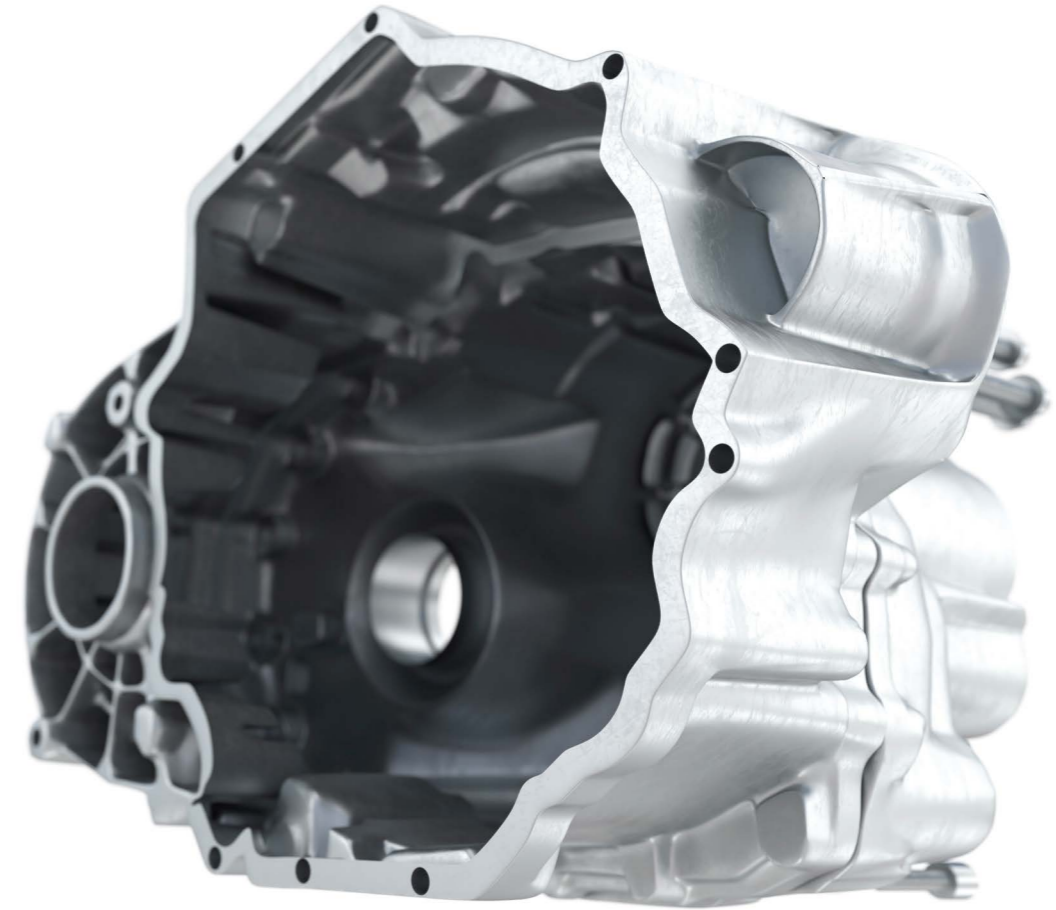
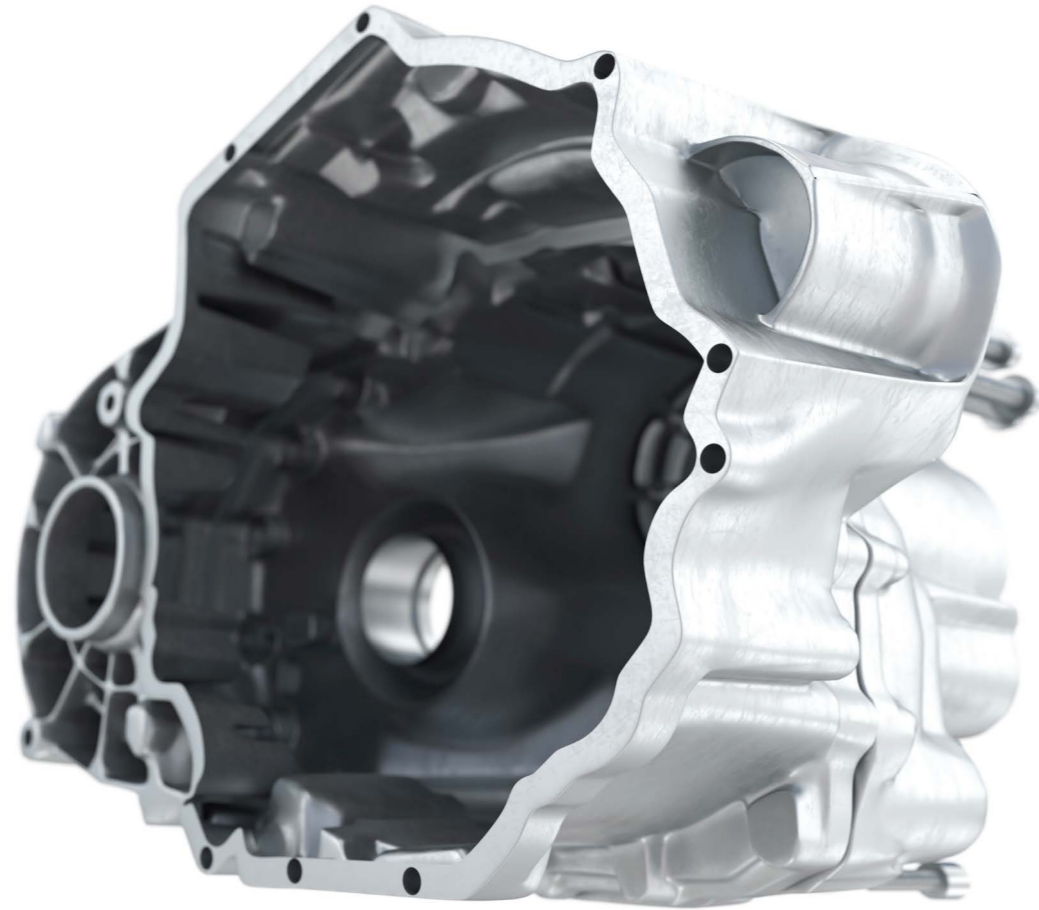

Don't guess. X-ray it inline.
ZEISS X-Ray Series

Many defects are hidden inside the parts – undetected, they can cause problems later in the process and, thus, lead to unnecessarily high costs. Make the invisible visible at an early stage and gain certainty about the quality of your castings.

Dare to see inside

During the complex manufacturing process of castings, various defects can occur that are not only on the surface. Inside, they can sometimes have a major impact on the stability of the part. However, incorrect geometries also make casted parts useless for later assembly. This is why it is important to detect defects reliably and early enough. This is possible thanks to X-ray technology – with only one scan!

Possible defects in terms of geometric deviations

Deformations

Particularly in the case of long, heavy castings, deformation may occur during further transport, if the material has not yet completely cooled down. These deformations become visible in a target/actual comparison, for example.

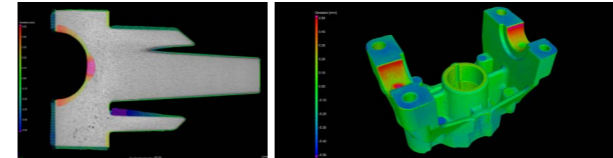

Displaced sand or salt core

If mistakes are made when positioning the core in the mold before casting, the geometries of the casting no longer match the CAD model. The component is, thus, no longer usable for assembly.

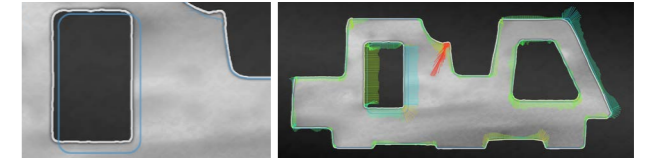

Possible defects inside or on the surface

Pores & porosity

Pores describe spherical gas inclusions which are caused by the gasification of e.g. release agents or due to inadequate die venting.

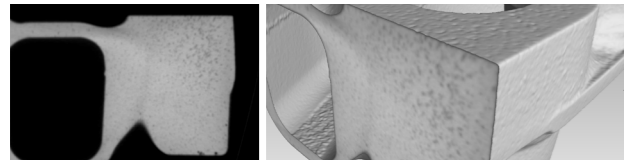

Shrinkage holes

Shrinkage holes are sharp-edged, gas-empty cavities that are often connected to each other. The reasons for this are e.g. too low holding pressure or suboptimal position of the gate.

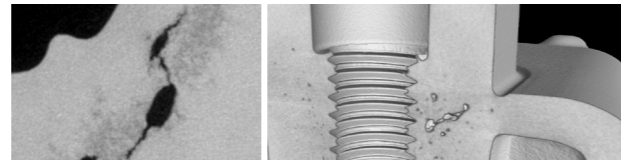

Spongy areas

Spongy areas are accumulations of small pores or shrinkage holes which can severely impair the stability of the casting.

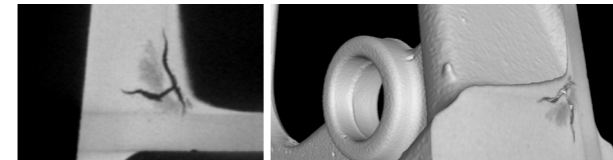

Blisters

The reason for bulging in the form of blisters on the casting surface is, for example, too high a casting temperature or plunger speed in the second phase.

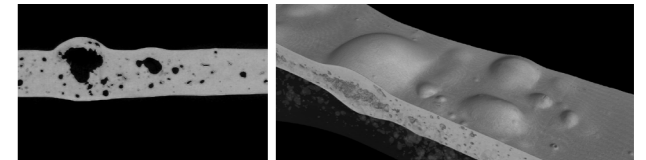

Cracks

Contaminations and an excessively high gate velocity can, for example, be reasons for the development of crack structures or thermal fatigue.

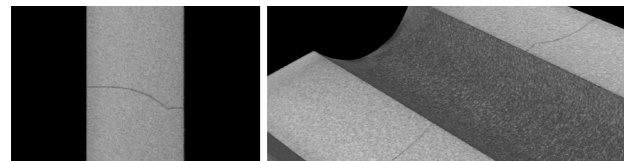

Flashes

Flashes are thin metal foils on the casting, caused for example by a too high gate velocity or an incorrectly adjusted clamping unit.

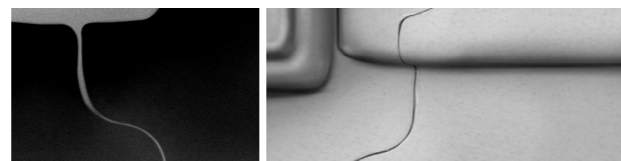

Inclusions

Inclusions are material components that are usually harder than the base material. They are caused, for example, by contaminated casting material.

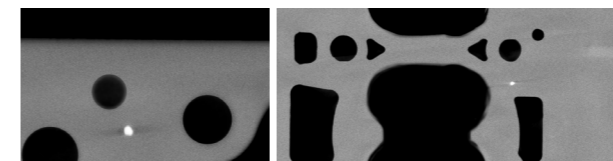

Sand or salt residuals

Often molding sand or salt remains inside the casting after decorating. With X-ray, this becomes visible and the part can be cleaned and then further processed.

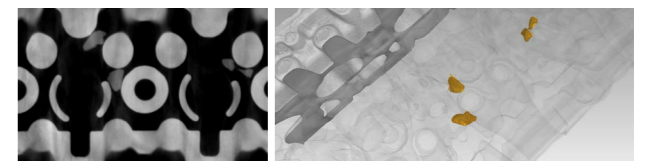

Broken core

The breakage or disintegration of a core can be caused e.g. by non-optimal mold material composition or excessive thermal stress on the casting material. This changes the structure of the mold so that the casted part has incorrect geometries.

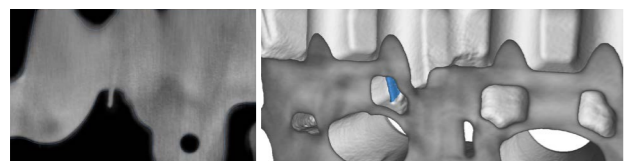

Incomplete filling

This defect describes areas of the casting that are not or not completely filled in, or whose contours are not clearly reproduced, for example due to insufficient plunger speed or insufficient holding pressure.

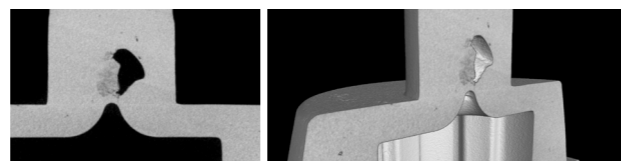

Joint & cold shot

This defect describes lines or grooves which are caused by a too low molding or melting temperature, sometimes also by a too long mold filling time.

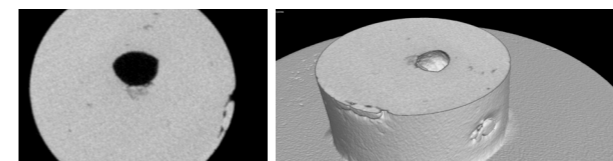

An investment that pays off

With each processing step after the casting process the costs for each part increase. Therefore, it is important to detect defects at an early stage, using 2D or 3D X-ray inspection in order to avoid unnecessary costs.

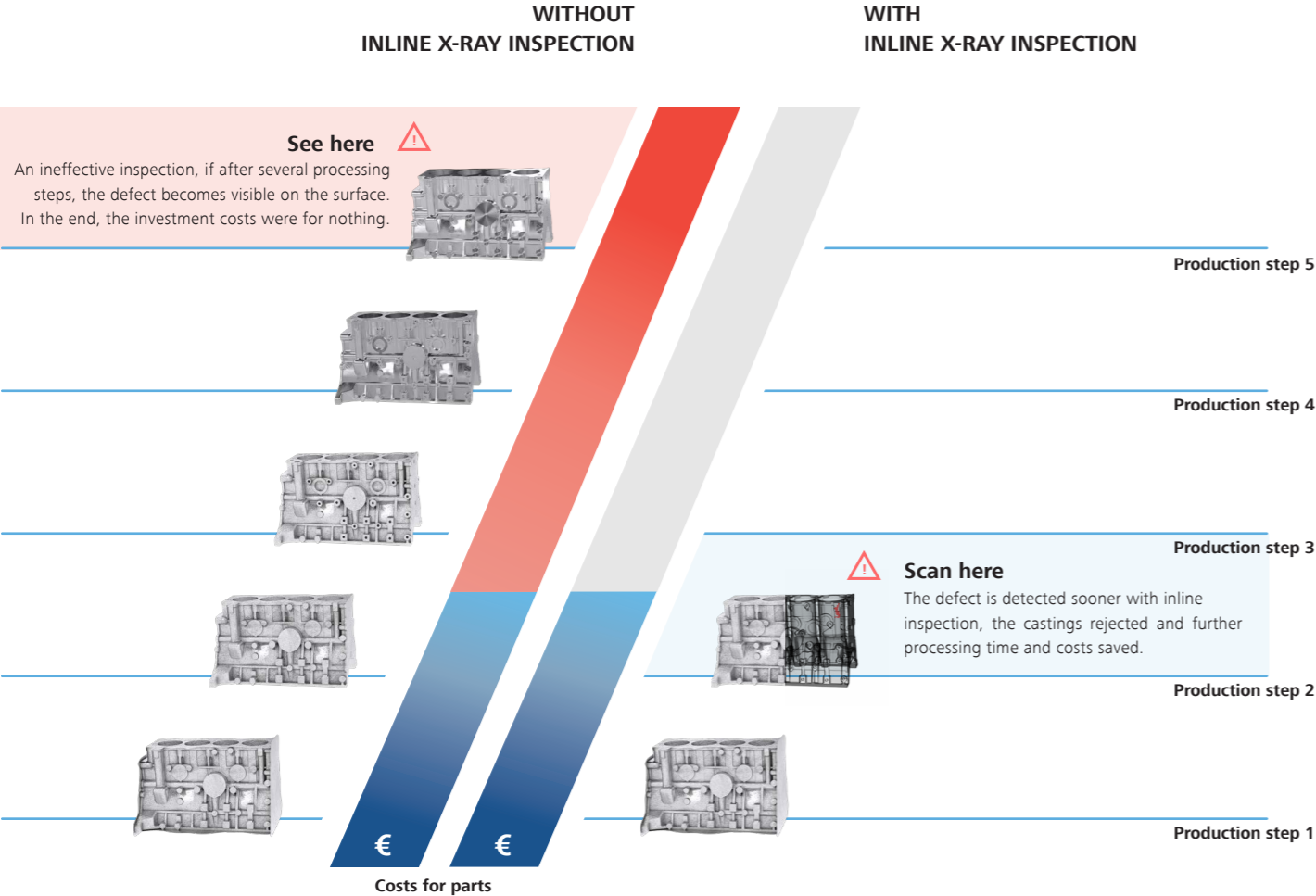

Amortization after 12 months

In the production of light metal parts, careful inspection directly after the casting process is important. Companies incur high costs, if defects are only detected late in the production process. Therefore, the investment in an automated inline solution for quality assurance usually pays off in less than twelve months.

State-of-the-art software

Reliable evaluation of defects – Set new standards thanks to modern machine learning software to unlock the full potential of your quality assurance: Not only does the software ZEISS Automated Defect Detection (ZADD) detect, locate and classify defects, but it also analyses them. On the basis of the CAD model it evaluates, whether the defect will cause a problem after further processing steps and needs to be sorted out. In the event that similar defects occur more frequently, the data management software ZEISS PiWeb recognizes this. In this way it is possible to intervene in the casting process at an early stage to reduce scrap and to save costs.

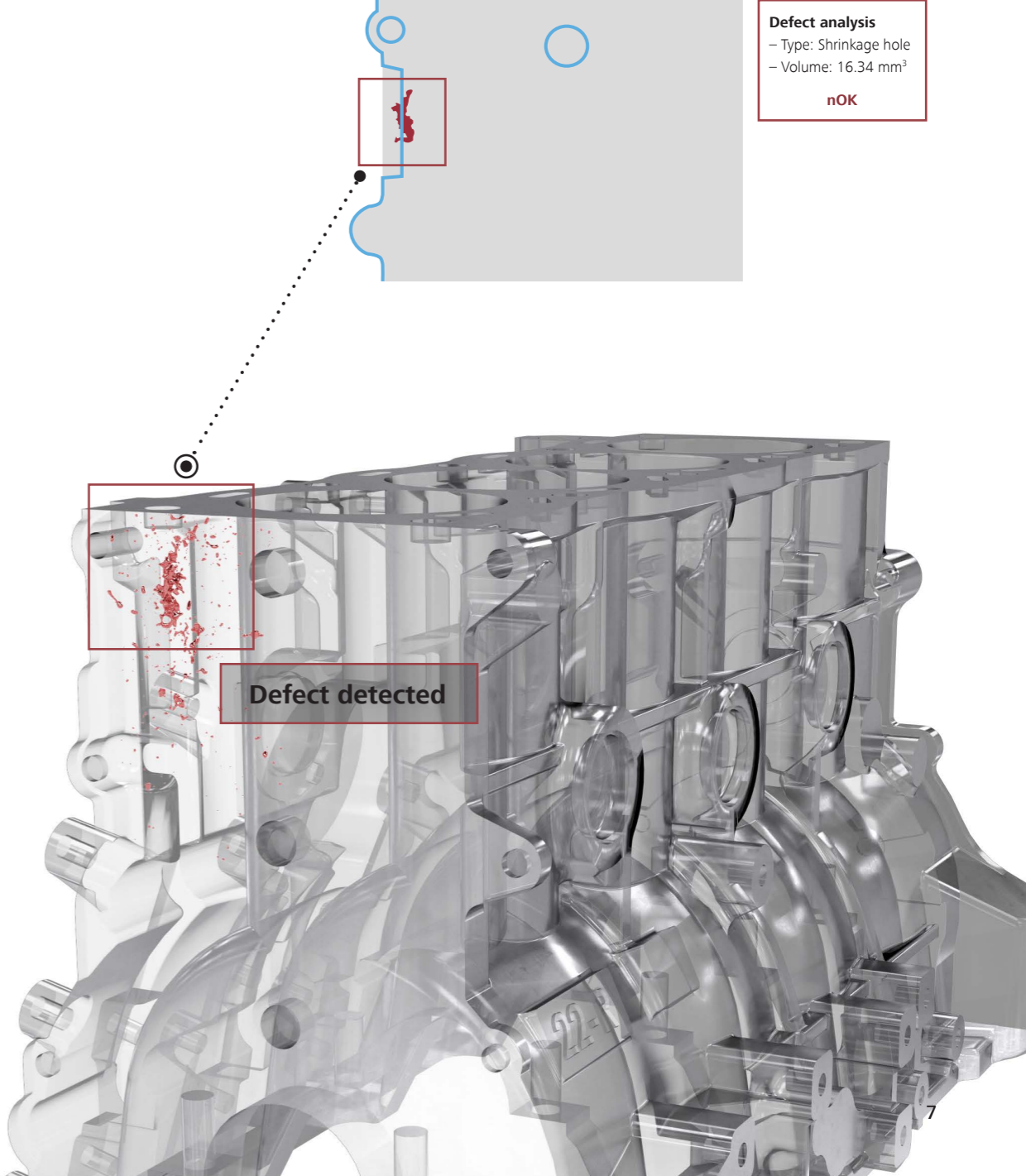

Discover all possibilities

3D inspection

New regulations often pose major challenges for the industry, especially in the automotive sector. In order to reduce emissions, the focus is, therefore, on lightweight construction. However, this also means greater fragility of castings. Internal defects, thus, have a much greater impact on the stability of the components. For this reason, it is important to precisely locate and measure defects. In contrast to the widely used 2D technology, this is possible with 3D X-ray technology. And not only that: ZEISS computer tomographs can be used in production to evaluate if a defect poses a risk after further processing steps. Early detection saves you unnecessary costs for further processing.

2D inspection

Detect shrinkage holes, pores, cracks, and other defects with only one scan – fast, automated, and reliable. The 2D inspection solutions of the BOSELLO product family are specifically designed for maximum throughput and minimum downtime in harsh production environments.

Metrology

X-ray solutions for metrology? ZEISS has more than a decade of experience in this field. Examine every detail of your casting: Checking the dimensional accuracy of internal features, target/actual comparison with a CAD model or wall thickness analysis. With the full insight, the possibilities are almost endless.

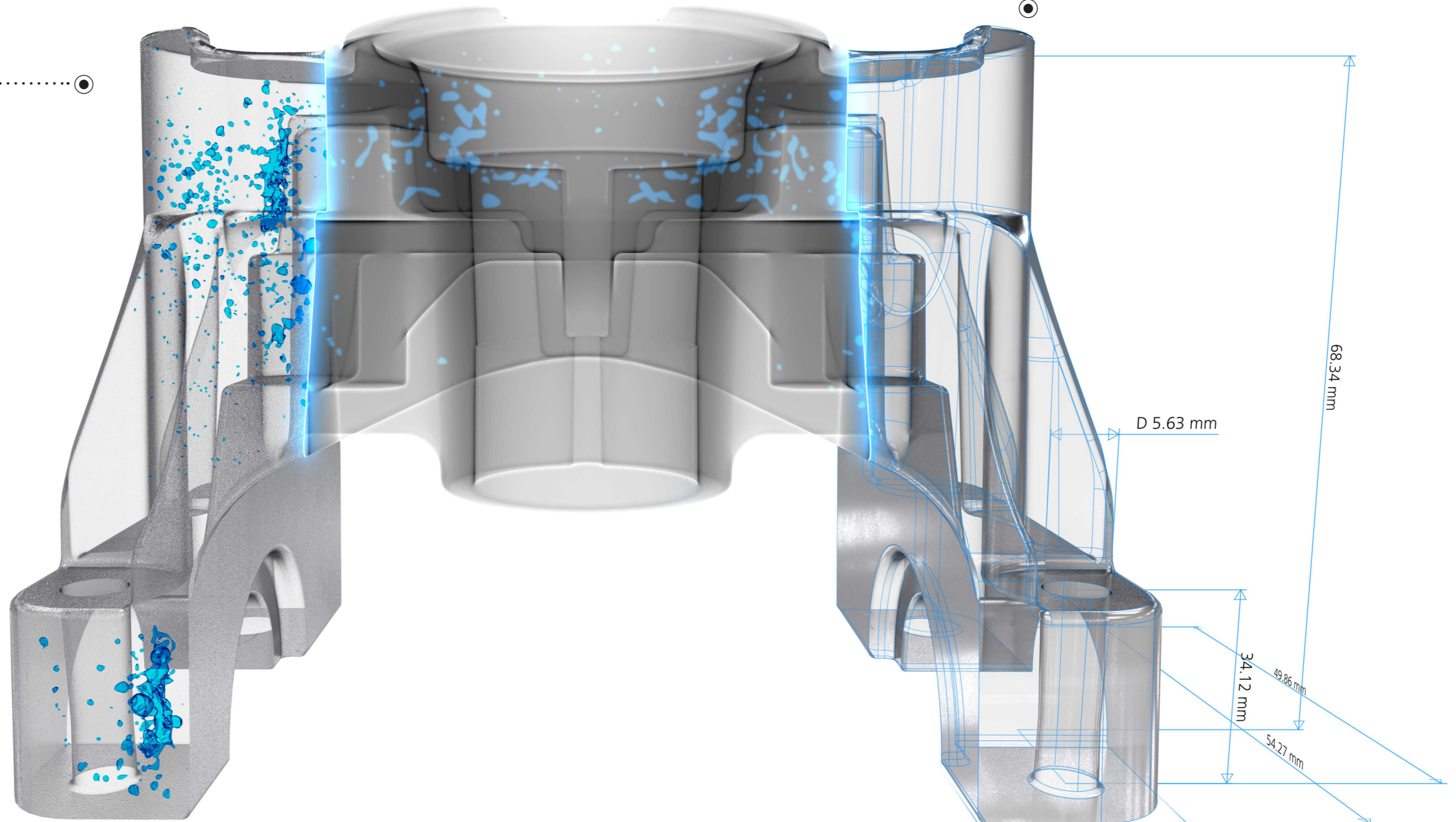

Find the perfect match

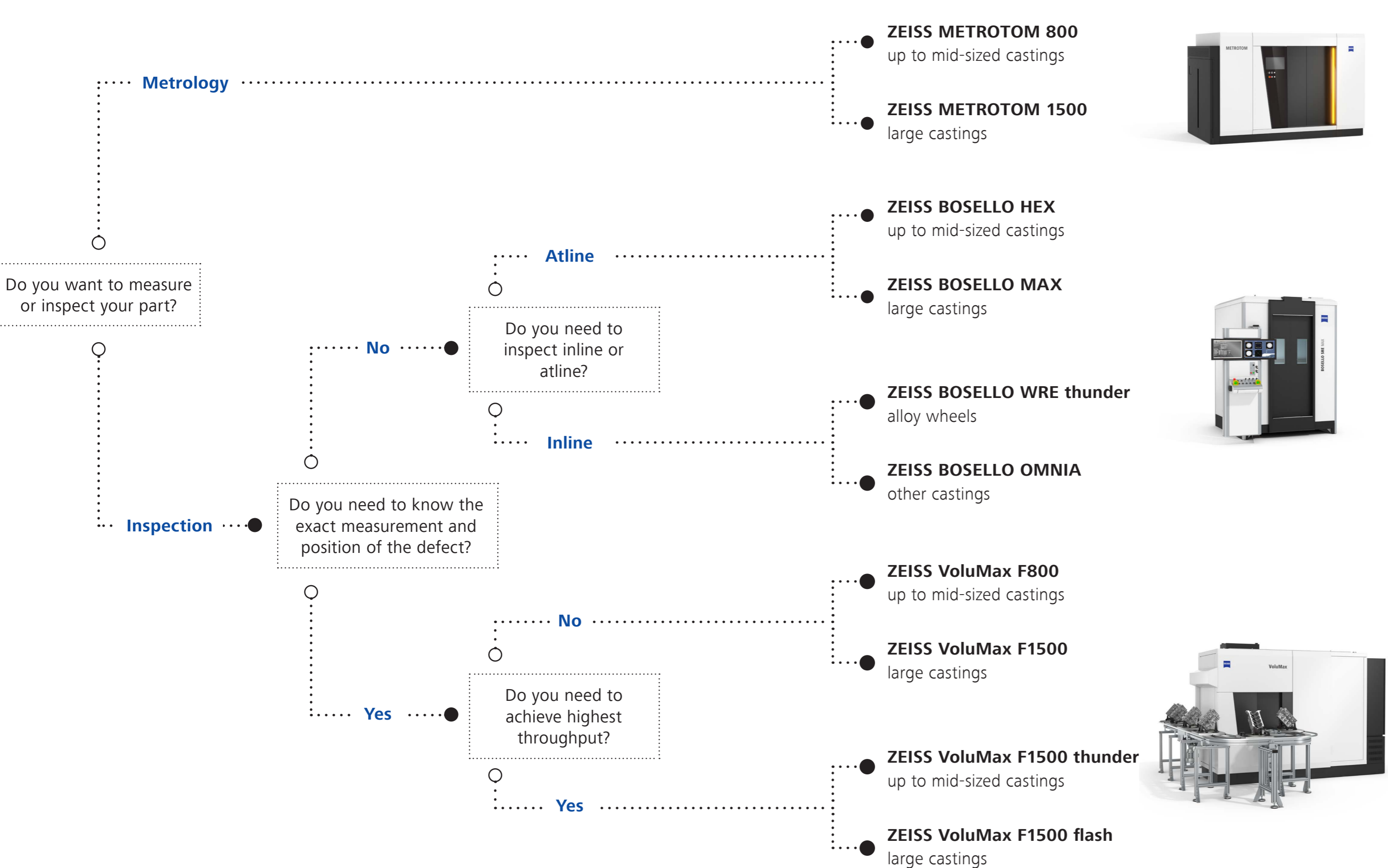

ZEISS METROTOM

For over a decade the ZEISS METROTOM family has been offering proven CT technology for quality control. The measurement specification, in accordance with ISO 10360, of ZEISS METROTOM guarantees highly precise, reproducible measurements on the 3D data set.

	Part size	Part density	Speed	Resolution	Accuracy	Footprint
ZEISS METROTOM 800 225kV	+	+	+	+	+	+
ZEISS METROTOM 1500	+	+	+	+	+	+

ZEISS BOSELLO

BOSELLO's industrial X-ray machines are robust systems that guarantee reliable non-destructive quality assurance inline and near production, and have been doing so for almost 40 years. Both the hardware, such as the generators, and the software are in-house developments.

	Part size	Part density	Speed	Resolution	Accuracy	Footprint
ZEISS BOSELLO HEX	+	+	+	+	+	+
ZEISS BOSELLO MAX	+	+	+	+	+	+
ZEISS BOSELLO WRE thunder	+	+	+	+	+	+
ZEISS BOSELLO OMNIA	+	+	+	+	+	+

ZEISS VoluMax

The inline CT ZEISS VoluMax generates 3D volume data within a few seconds and is insensitive to temperature changes. This makes it ideally suited for 100 percent inspection in the production when many parts have to be inspected very quickly.

	Part size	Part density	Speed	Resolution	Accuracy	Footprint
ZEISS VoluMax F800	+	+	+	+	+	+
ZEISS VoluMax F1500	+	+	+	+	+	+
ZEISS VoluMax F1500 flash	+	+	+	+	+	+
ZEISS VoluMax F1500 thunder	+	+	+	+	+	+

All benefits at a glance

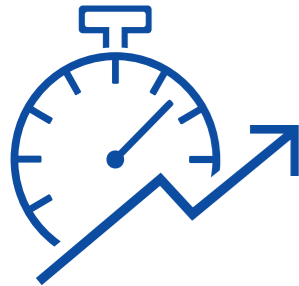

1. PRODUCTIVITY

- Meeting cycle times through fast 100 percent inspection directly in the production
- Detect defects early and save money
- An investment that pays off in a very short time
- Get all information in one scan
- Identify problems in production at an early stage and, thus, reduce scrap
- Continuous process control thanks to ZEISS PiWeb



2. SERVICE

- One-stop solution provider
- Robust solutions thanks to many years of experience in the production environment
- Guaranteed availability & fast service
- Best price/performance ratio
- Fast support thanks to worldwide service & immediate availability of spare parts



More information on:
www.zeiss.com/x-ray/light-metal