

Sinterit LISA PRO

USER MANUAL



Please read the instruction manual before using the device.





To ensure the safe use of the Sinterit LISA PRO Printer, please read and follow the instructions below. Keep this manual for future use. Also, be sure to follow all warnings and instructions marked on the product.

Table of contents

1. Marking text conventions used in this manual	3
2. Dictionary	5
3. Important safeguards and warnings	5
A. Environment and place of installation	5
B. General safety rules	6
C. Personal protection.....	7
D. Power supply and grounding system.....	7
E. Safety requirements during using the sinterit Lisa PRO printer	8
F. Safety during repair and maintenance.....	9
G. Working with powders	10
H. Rating place (specification tag and symbols).....	11
I. Scrapping	11
4. Contents of the sinterit Lisa PRO pack	12
A. Flightcase overview and startup box equipment	12
B. Unpacking lisa pro from flightcase	12
5. Sinterit Lisa PRO 3D printer	14
A. Description.....	14
B. Specification	16
6. Preparing the Lisa PRO printer to work after delivery	18
A. First steps	18
B. Installing the laser protective glass	21
C. Connecting the printer to wi-fi network.....	22
D. Last steps before start printing.....	23
7. Main menu - what, where, how? Short explanation of functions.	24
8. Printing - simple mode	25
9. Information and tasks while printing	31
10. Printing with nitrogen installation	33
A. Nitrogen installation - messages and sound signals.....	33
B. Preparing installation to print	33
11. Finishing the print	34
A. Removing the printout	34
B. Cleaning the printer using the PHS Device, Sinterit Atex Vacuum Cleaner or Cleaning System.....	37
C. Cleaning the printer in manual option.....	40
12. Cleaning the prints and postprocessing	43
A. Cleaning of the printouts with sinterit PHS Device	43
B. Cleaning of the printouts with dedicated tools	45
C. Postprocessing: painting and lacquering	47
13. Powder refreshment process	47
A. Refreshing the powder using the PHS Device.....	48
B. Refreshing the powder using the Powder Sieve or Metal Sieve	49
14. Printing - advanced mode	50
15. Working with the powders	54
A. Materials use with nitrogen	54
B. Rules and procedure for changing the powder in the printer	54
C. Cleaning the machine when changing powder	54
16. Maintenance and daily service of the sinterit Lisa PRO printer	57
A. Daily service work while printing	57
B. Laser protective glass - cleaning and replacing	57
C. Service area under beds - cleaning	58
D. Short infrared heaters - cleaning and replacing	59
E. Recoater cord - replacing	59
17. Packaging guide for Lisa PRO printer	60
A. Preparing Lisa PRO printer to be packed.....	60
B. Packaging Lisa PRO printer to flightcase	60
18. General legal information	61
19. Disclaimer	61
20. Trademarks	61
21. Software license agreement	61
22. Terms of warranty	62
23. Technical support	62



1. Marking text conventions used in this manual

Listed below are descriptions of symbols used on the device. They constitute a warning or convey the information to protect the user, other individuals or surrounding objects and ensure the correct and safe use of the device.

	<p>WARNING! An inevitably dangerous situation which can result in serious injury or even death. Initiation, omission of a specific procedure or inattention can cause severe physical injury to the user.</p>
	<p>ATTENTION! Initiation or omission of a specific procedure can cause physical damage to the equipment or the user.</p>
	<p>WARNING! Risk of electric shock which can be fatal or cause severe burns. An inevitably dangerous situation which can result in serious injury or even death, if not mitigated. Before working with any equipment, you should be aware of the dangers associated with the flow of electric current, and become familiar with the standard procedures to prevent accidents.</p>
 	<p>WARNING! Compressed gas! The danger of suffocation! Possibility of unsealing - gas has a suffocating effect on people by displacing oxygen from the air. Too low oxygen concentration in the air can lead to unconsciousness and death, if not mitigated. Inhalation exposure may cause short breath, breathing difficulties, headaches and dizziness, with high concentrations of gas disorders of orientation, nausea, fainting, loss of consciousness, death.</p>
	<p>CAUTION! IR laser radiation. Looking directly into the laser beam can cause blindness and skin burns. The laser emits infrared radiation (infrared, IR), which is invisible to humans. Avoid eye or skin exposure to direct or scattered radiation. Do not stare into the beam or view with optical instruments.</p>
	<p>CAUTION! High temperature – do not touch. Excess heat dissipation can cause burns.</p>
	<p>CAUTION! Beware of moving parts which can crush hands.</p>
	<p>CAUTION! Beware of sharp edges which can cause body cuts and injury.</p>
	<p>CAUTION! Beware of intense light.</p>



 	<p>WARNING! Risk of fire and explosion! Avoid fire! Powder dust is flammable.</p>
	<p>ATTENTION! Risk of electric shock. A grounding is used in the printer. Follow the instructions in the User manual and the markings on the printer.</p>
	<p>STOP! Action prohibited.</p>
 	<p>ATTENTION! It is necessary to wear adequate protective clothing, eyewear, face mask, and gloves. Mandatory action when working with powder.</p>
	<p>ATTENTION! It is necessary to wear antistatic clothes and shoes. Mandatory action when working with powder.</p>
	<p>IMPORTANT! Information essential to correctly perform a specific task.</p>
	<p>IMPORTANT! You must read the instructions before taking action.</p>





2. Dictionary

The following terms and forms have been adopted and used in the manual.

- **SINTERIT LISA PRO 3D PRINTER** - (Lisa PRO, 3D printer, printer, machine, device) – a selective laser sintering (SLS) machine used in additive manufacturing (AM) processes. The device dedicated to professional and quick manufacturing of three dimensional (3D) models of spatial objects.
- **SINTERIT STUDIO 2019 (STUDIO, Sinterit STUDIO)** - dedicated software for the Sinterit printers. Sinterit STUDIO as a desktop application allows to prepare 3D models (set them in the printable area - called PRINT BED) and track the print status of the printer during the printing process.
- **POWDER, PA, FLEXA, TPE, MATERIAL** - powder material dedicated to printing in SLS technology. Powders from the PA, TPU or TPE group, with granulation 20-105 µm and the sintering temperature up to 195 oC / 383 oF .
- **RECOATER** - tool in the form of a roller, moving on a guide bar using a cord. Used to transfer the powder from the FEED BED to the PRINT BED during the printing process.
- **FEED BED** - a chamber storing new, unsintered powder.
- **PRINT BED** - a chamber where the sintering of powder takes place, creating the printed 3D model.
- **OVERFLOW BIN** - a chamber used to collect the excess unsintered powder, transferred from the FEED BED to the PRINT BED by the RECOATER.
- **NITROGEN CHAMBER** - a built-in chamber that is an integral part of the device, allowing connect gas (nitrogen or argon) and working in a controlled atmosphere. Only some powders are suitable for printing using it. Check the description on the material.
- **PRINT READY POWDER** - powder ready to be used by the printer - the combination of sintered in the previous printing process USED POWDER and FRESH POWDER.
- **FRESH POWDER** - virgin powder, used for refreshing PA12 and PA11. Needs to be mixed with the USED POWDER in correct proportions. FRESH POWDER is not suitable for printing (the print may not be successful).
- **USED POWDER** - all the unsintered powder that remains after the printing and cleaning process. Suitable for printing if we are using TPU based material. If using material from PA group and TPE - suitable for printing after refreshing by adding FRESH POWDER, in indicated by the software proportions (different for every material).

3. Important safeguards and warnings

	<p>WARNING!</p> <ul style="list-style-type: none"> • Unless these messages are heeded, operator injuries could occur. • Unless these messages are heeded, printer damage could occur.
	<p>WARNING!</p> <p>The following indications are, by themselves, not enough to fully protect against all the hazards that could arise during printer operation. These will have to be integrated with common sense and the experience of the operator, both of which are crucial factors for preventing accidents. Each section of this manual lists further specific safety warnings for the various operations.</p>

A. ENVIRONMENT AND PLACE OF INSTALLATION

	<p>WARNING!</p> <ul style="list-style-type: none"> • The printer must be protected against atmospheric agents (rain, hail, snow, fog, dust in suspension, etc.) with an environmental temperature between 0°C and 40°C and relative humidity not above 70%. • The work environment must be clean, well-enough lit and devoid of any explosive materials, that may create an explosive atmosphere. • The work environment must be well ventilated, adequately to its size. • The printer should be used in a room at around 22 [°C] / 72 [°F] and should not be placed near the air conditioner's vents.
---	--



	<p>IMPORTANT!</p> <ul style="list-style-type: none">• The product should be placed on a flat, stable surface that extends beyond all edges of the product.• If you place the product by the wall, the distance between the product and the wall should be greater than 50 [cm] / 20 [in].• We suggest using the Sinterit Platform. Its dimensions are adapted to the requirements of the Sinterit Lisa PRO printer.• The product will not work properly if it is set at an angle.	
	<p>STOP! Do not place or store the printer:</p> <ul style="list-style-type: none">• outdoors;• near water, or heat sources;• in areas with large amounts of dust;• in places subject to shocks, vibrations, high temperature and/or humidity;• extreme changes in temperature and humidity;• near inflammable and volatile substances, concentrated acids or corrosive vapours;• in places easily accessible to children and animals.	
	<p>STOP!</p> <ul style="list-style-type: none">• The printer emits large amounts of heat (60 [°C] / 140 [°F]), and therefore it is prohibited to place it on the wood or wooden furniture.• Never use wood, equipment with wooden elements and flammable substances while working with the printer.• The min. distance between the printer and wooden parts is 50 [cm] / 20 [in].	
	<p>STOP!</p> <ul style="list-style-type: none">• The printer must not be operated in a corrosive or explosive environment.• Avoid using the device close to open flames or sources of heat.• Do not disconnect while the circuit is live or unless the area is free of ignitable concentrations.• Do not connect or disconnect when energized.	

B. GENERAL SAFETY RULES

	<p>WARNING!</p> <ul style="list-style-type: none">• Only trained and qualified personnel should install, replace or service the equipment.• The device should be installed in accordance with these instructions and by trained personnel.	
	<p>WARNING!</p> <ul style="list-style-type: none">• Only adults should use the printer.• When using the machine, mind other people, especially children.	
	<p>ATTENTION!</p> <ul style="list-style-type: none">• Risk of crushing upper limbs while closing the printer Lid.• Never place hands between the Lid and Print Chamber while closing.• Do not put your hands in the Service area of the BEDs when the BEDs are running (in case of a removed Removeable Front Panel).• Be aware when removing and installing the lid from the Nitrogen chamber and Overflow Bin.• Do not remove the Removeable Front Panel during printer operation.	



	ATTENTION! When restoring original working conditions, the appointed personnel should make sure that at the end of the operating procedure, proper printer operation safety conditions are restored, especially the safety devices and the protective guards.	
	ATTENTION! <ul style="list-style-type: none">• Never leave miscellaneous materials on the printer Lid.• Make sure all the guards and protection of the printer are in place and that all the safety devices are in place and working properly.	
	STOP! Climbing on the printer is forbidden.	









C. PERSONAL PROTECTION

	ATTENTION! Wear individual protections. Before starting any work with powder, always wear adequate protective clothing, eyewear, face mask, and gloves.	
	ATTENTION! <ul style="list-style-type: none">• The operator must always wear antistatic clothes and shoes.• The floor in the working area must be antistatic.	
	WARNING! Avoid prolonged contact with powders and inhaling their vapours.	
	STOP! Do not wear loose or hanging clothing such as ties, scarves or torn garments that could become trapped by the printer.	

D. POWER SUPPLY AND GROUNDING SYSTEM

	WARNING! <ul style="list-style-type: none">• Before plugging in, make sure the power voltage and frequency are those shown on the machine plate.• When an extension cord is used for the power supply of the product, make sure that the total power consumption of all devices connected to it does not exceed the extension cord's limit. Also, make sure that the total current drawn by connected equipment does not exceed the ampere rating for AC wall outlet.	
--	---	--









	<p>WARNING!</p> <ul style="list-style-type: none">• Use only the Power cable supplied with the product.• Do not use power cables from other devices! Using the power cables from other devices or connecting the power cables supplied with the product to other devices may cause fire or electric shock.• The power cable should be placed in such a place that they are not rubbed, cut, pulled or twisted.• Pay special attention to the fact that the Power cable is not bent at the points of connection of the printer.• During use, mind the power supply cables and avoid crushing or pulling these.• Periodically check the mains power cable to ensure it is not damaged.• In the event of the cable being replaced, make sure it is protected against water spray and check mechanical strength.• Disconnect the Power cable whenever it is planned to shift/transfer the machine.	
	<p>WARNING!</p> <p>In the following situations, unplug the product from the power supply and contact with Sinterit Support:</p> <ul style="list-style-type: none">• the power cord or plug is damaged;• some liquid got into the product;• the product has been dropped or the case has been damaged;• the product does not operate properly or clear changes in efficiency have been observed.	
	<p>STOP!</p> <ul style="list-style-type: none">• Never touch electric wires, switches, buttons, etc. with wet hands.• Never pull the machine by means of the power cable. When connecting/disconnecting the plug to/from the power socket always hold the cover, not the cable.• In the event of the cable being damaged, the machine must not be used.• Never disassemble, modify or repair the power cable, plug, devices inside the printer, except as described in the product manual.• Do not place objects on the Power cable.• Do not place Power cable in a path where people will have to walk or run.	
	<p>ATTENTION!</p> <p>It is recommended to use UPS units that, in the case of a momentary power failure, will allow the printing process to finalise.</p>	
	<p>ATTENTION!</p> <ul style="list-style-type: none">• The printer must be connected to a grounded outlet to prevent electric shock in the event of a fault.	



E. SAFETY REQUIREMENTS DURING USING THE SINTERIT LISA PRO PRINTER

	<p>WARNING!</p> <p>Before printing always make sure the printer is free of all external materials such as debris, oil, equipment and other objects that could affect the operation and cause injury to persons.</p>
---	--





	<p>ATTENTION!</p> <ul style="list-style-type: none">• During printing, if there is a lot of smoke, irritating smell or other alarming circumstances take place, press the Safety button. It will immediately cut off the power from the printer.• However, remember that it is impossible to open the printer (e.g.: by lifting the Lid) until the temperature inside will not drop below 50°C and the UNLOCK LID option becomes available.	
	<p>WARNING! <u>NITROGEN INSTALLATION</u></p> <p>Possibility of unsealing - gas has a suffocating effect on people by displacing oxygen from the air. Too low oxygen concentration in the air can lead to unconsciousness and death. Inhalation exposure may cause short breath, breathing difficulties, headaches and dizziness, with high concentrations of gas disorders of orientation, nausea, fainting, loss of consciousness, death.</p> <ul style="list-style-type: none">• Store in a well-ventilated place.• Do not inhale the gas.• Nitrogen is an inert gas, a natural component of atmospheric air. It is not harmful in the aquatic environment or soil, its adverse effect is limited to the displacement of oxygen.• The built-in oxygen level sensor is not a certified device and the signal cannot be treated as the only warning. Keep the Lisa PRO printer and the nitrogen bottle in well-ventilated rooms.• If you hear an alert, open the windows/ventilate the room and leave the room.• If you feel any suspicious symptoms, immediately leave the room and go outside/to a well-ventilated room.	 
	<p>ATTENTION! <u>LASER PROTECTIVE GLASS</u></p> <ul style="list-style-type: none">• The cleaning process of the Laser Protective Glass should be carried out outside of the printer.• Do not clean the Laser Protective Glass under running water.• Only use products with ethyl alcohol. We recommend Alcohol pads (available in the Service Kit).	
	<p>ATTENTION!</p> <p>While the printer is working do not touch any other elements besides: the LCD touch screen, the Safety button, the USB port and the Power switch.</p>	











F. SAFETY DURING REPAIR AND MAINTENANCE

	<p>WARNING!</p> <ul style="list-style-type: none">• Only skilled persons should carry out repairs.• Read the operator's and maintenance manual carefully before using the printer or doing any maintenance jobs.• During cleaning operations, maintenance jobs or when changing parts, the Power switch must be off and the machine must be unplugged by removing the Power cable from the socket.• During maintenance jobs, affix a notice to the appliance indicating „MACHINE BEING SERVICED, DO NOT START“.• Do not adjust controls that are not described in the manual.	
---	--	---





	<p>WARNING!</p> <ul style="list-style-type: none">• Structural damage and improper alterations or repairs could change the protection capacity of the printer and therefore cancel the guarantee.• Any alterations to the appliance can only be made by Sinterit Support.• In the event of Customers fitting a tool to the machine not supplied by Sinterit, make sure the safety conditions required by Machine Directive 2006/42/CE are complied with and in any event, Sinterit is unable to accept liability for any problems arising from the use of such tool.	
	<p>STOP! Avoid using flammable or toxic solvents such as petrol, benzene, ether and alcohol for cleaning.</p>	

G. WORKING WITH POWDERS

	<p>WARNING!</p> <ul style="list-style-type: none">• When working with the polyamide powder or other designated printer powder for the Sinterit Lisa PRO printer, always wear Personal Protection dedicated to this device (Protective Glasses, Protective Gloves, Protective Dust Mask).• When working with a powder, avoid inhalation or swallowing and contact with skin and eyes.	 
	<p>ATTENTION!</p> <ul style="list-style-type: none">• Polyamide powder should be stored in tightly closed containers (e.g Sinterit Metal Container), in a room at room temperature and low humidity.• The powder should be stored out of reach of children and pets.• If the device is not used for a long time, the powder should be removed from the printer and stored in a sealed package (e.g Sinterit Metal Container).	
	<p>ATTENTION! When printing the smell of melting material may be emitted in intensities which do not affect the health of users. However, in the case of long-term operation of the printer in a poorly ventilated room, the smell may become unpleasant and irritating. Adequate ventilation is recommended in order to create the best printing conditions.</p>	
	<p>STOP! Do not attempt to burn/melt polyamide powder. The resulting sparks and hot mass can cause severe burns. Keep the powder material away from fire.</p>	 
	<p>STOP! Do not dispose of in municipal waste! The used powder material should be stored in sealed containers and disposed of in accordance with local policy of waste plastic material.</p>	

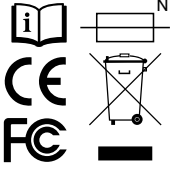

H. RATING PLACE (SPECIFICATION TAG AND SYMBOLS)

DO NOT REMOVE THIS LABEL!						
Manufacturer:  SINTERIT Sp.z o.o. ul. Nad Drwiną 10 bud. B3, 30-741 Kraków, Poland www.sinterit.com contact@sinterit.com			Name: SINTERIT LISA PRO			
			Serial number: 1234597890			
		Manufactured:	Made in: EU, POLAND			
IEC Protection Class:		Machine type::	SLS 3D PRINTER (SELECTIVE LASER SINTERING)			
 Class 1		Dimensions:	725 x 635 x 1020 mm			
		Total weight:	90 kg			
		Power consumption:	220-240 V AC, 50/60 Hz, 7 A, 1.9 kW			
IP Code:	IP30	Max temperature:	Internal:	210°C	External:	60°C
		Contains devices FCC:	FCC ID: TE7WN725N			
		Laser product class:	CLASS 1 IR LASER PRODUCT			
		Embedded laser product class:	Wavelength:		λ = 808 nm	
			Beam divergence:		θ = 10°	
			Beam output:		CW (CONTINUOUS WAVE)	
Maximum power:			5 W			

View of the specification tag in the Sinterit Lisa PRO printer.



ATTENTION!

- Make sure all the safety messages are legible.
- Clean these with a cloth, soap and water. Do not use solvents, diesel fuel or petrol.
- Replace the damaged plates with new ones supplied by Sinterit. If a plate is attached to a replaced part, make sure a new plate is affixed to the new part.
- When contacting the manufacturer or dealer, always quote the details shown on the printer plate.



WARNING!

- Removing the safety plates on the printer is strictly forbidden!
- The manufacturer declines all liability in relation to printer safety in the event of failure to comply with the above indications.

I. SCRAPPING



IMPORTANT!

In the case of scrapping, all the component and parts of the printer will have to be disposed of through adequate disposal channels in accordance with applicable legislation. Before scrapping, all plastic and rubber parts will have to be separated from the electrical material. Parts made of plastic, aluminium and steel only may be recycled if collected by special centres.

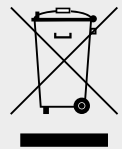



4. Contents of the Sinterit Lisa PRO pack

	<p>IMPORTANT! Keep all the original boxes and transport protection. You may need them to pack the machine in the future if necessary.</p>
	<p>WARNING! Two adults are needed to unpack the printer safely! <u>The Flightcase with Lisa PRO printer weighs approx 120 [kg] / 265 [lbs].</u> Do not lift it yourself!</p>
	<p>ATTENTION! <u>The printer weighs almost 100 [kg] / 220 [lbs].</u> Make sure, that the furniture or surface, that you plan to place the printer on is appropriate for such load.</p>
	<p>ATTENTION!</p> <ul style="list-style-type: none"> • The device can be transported only in its original package in the way that prevents it from moving inside. • It should be also thoroughly protected against any environmental factors that could affect it. • The device should be stored indoors in original packages in spaces without chemical fumes or reactive substances, at a temperature between 0°C÷40°C and relative humidity not higher than 80%.

A. FLIGHTCASE OVERVIEW AND STARTUP BOX EQUIPMENT

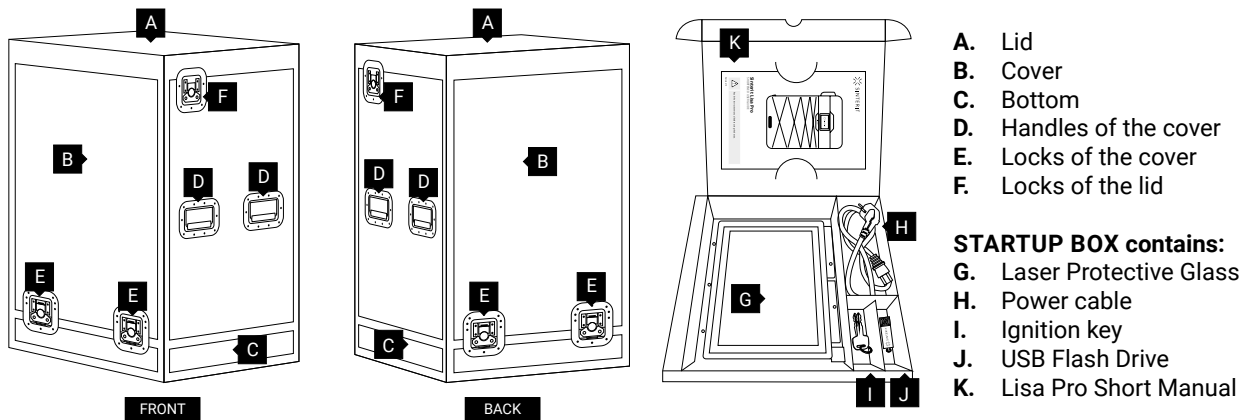

B. UNPACKING LISA PRO FROM FLIGHTCASE

1. REMOVE THE FLIGHTCASE WITH THE PRINTER FROM THE TRANSPORT PALLET

Grab the two handles on both sides of the Flightcase **D** (two people needed). Carefully remove the Flightcase from the pallet and place it on a stable surface.

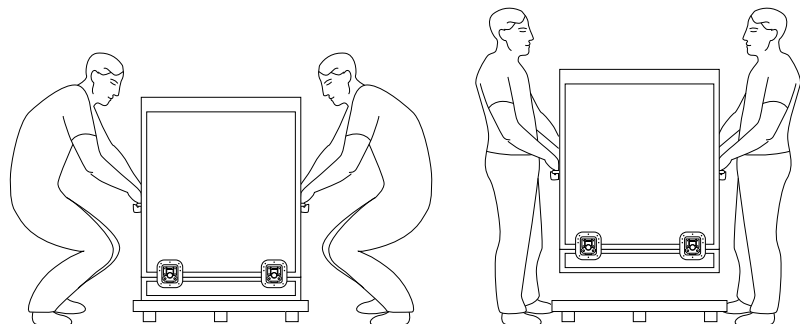

The correct transfer of the Lisa PRO Flightcase from the pallet.



2. UNLOCK THE LOCKS OF THE FLIGHTCASE COVER

Unlock 4 locks on the lower part of the the Flightcase cover **E** (2 on the front and 2 on the back).

Turn the lock handle by 90 degrees **a**, **b**. Rotate the lock handle approx. 225 (180 + 45) degrees CCW until the hook opens **c**. Repeat on each of the four locks of the Flightcase cover.

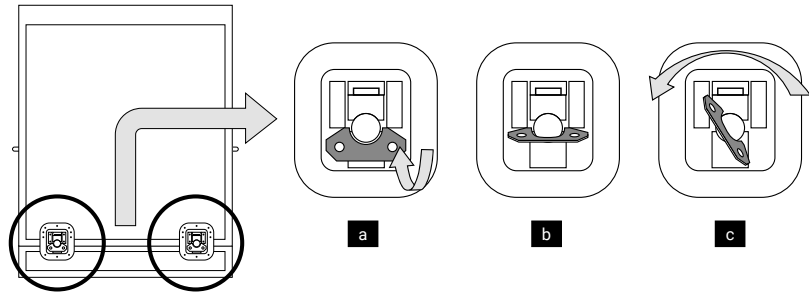

Unlocking the lock of a Flightcase's cover.

3. OPEN THE FLIGHTCASE

Carefully grab the handles of the cover on both sides of the the Flightcase **D** (two people needed) and lift it to a height of minimum one meter.

Be careful, not to snag the printer!

Place the cover in a safe and stable place. Remove all foils from the outside of the printer. Make sure that the Lisa PRO hasn't been damaged during the transport. Check against any visible signs of it.

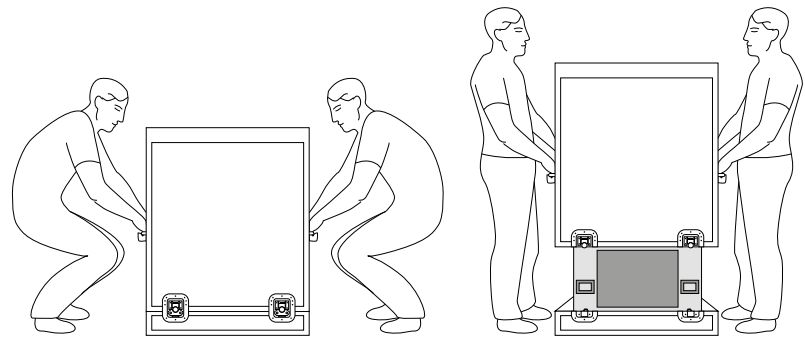

Correct lift of the cover from Lisa's PRO Flightcase.

4. MOVE THE PRINTER FROM THE FLIGHTCASE TO THE TARGET WORKSTATION

Grab the printer holders **4**, **17** (see picture  for front and back), carefully lift it up and place it on a stable surface. We recommend the target workstation.

Ensure that the printer is placed in a location where its size and weight will be properly supported.

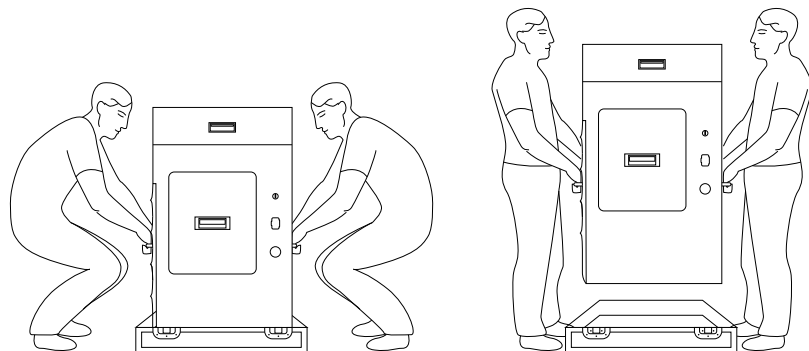

Correct lift of Lisa PRO from the Flightcase.



IMPORTANT!

Remember to register your printer and activate your software at sinterit.com/register

The registration gives you the fastest possible access to software updates, support tips and expert knowledge from our specialists.



5. Sinterit Lisa Pro 3D printer

A. DESCRIPTION

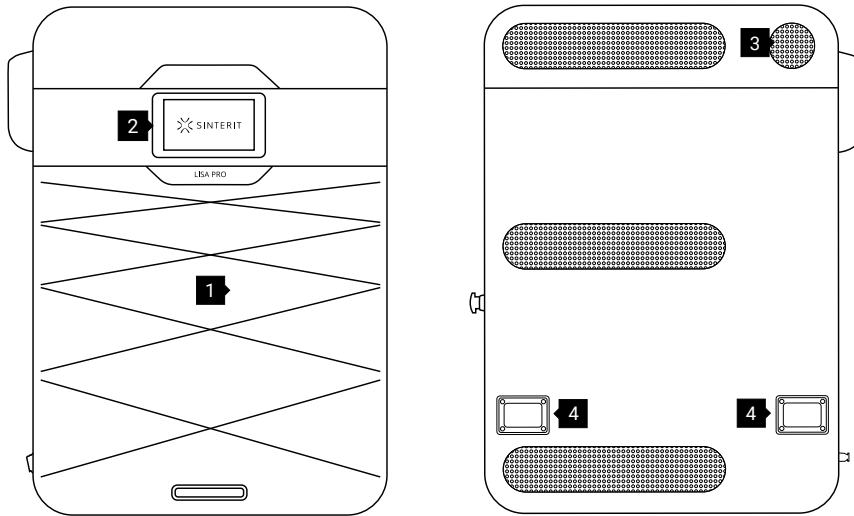

View of the printer's front and back side.

1.Removable Front Panel / 2.LCD touch screen (with Camera view) / 3.Lid fan / 4.back holders

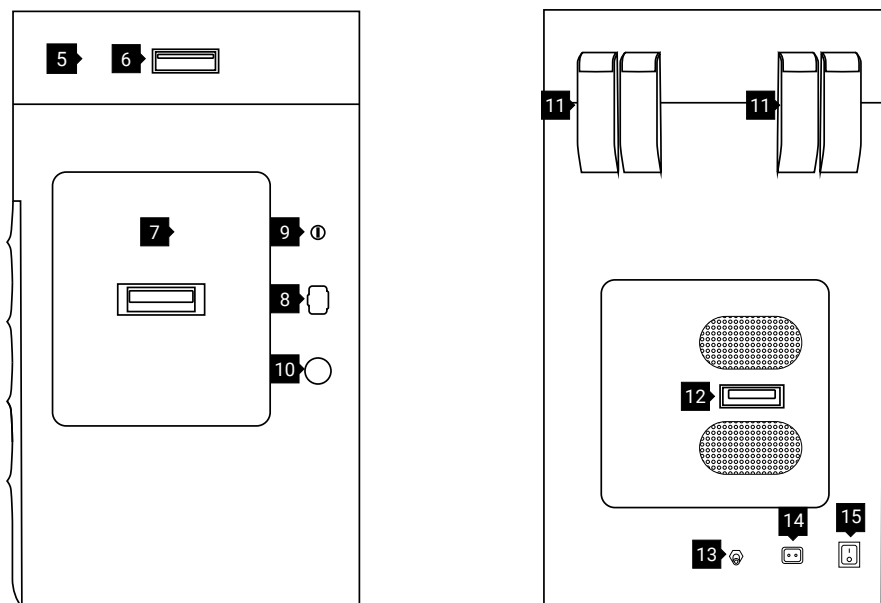

View of the printer's right and left side.

5.Printer lid / 6.Lid handle / 7.Overflow Bin / 8.USB port / 9.Key slot / 10.Safety button (E-STOP) / 11.Lid hinges / 12.Nitrogen installation / 13.Nitrogen inlet nipple / 14.Power socket / 15.Power switch (On/Off)

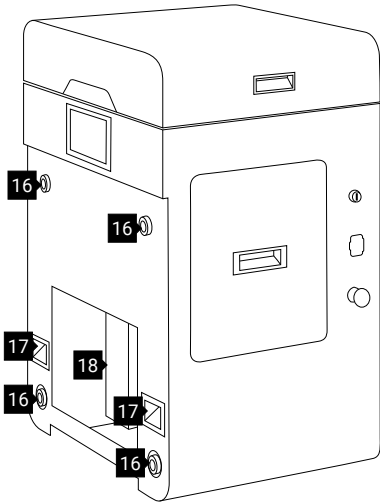

View of the printer without a front panel.
 16.Magnetic fasteners / 17.Front holders /
 18.Service area under BEDs

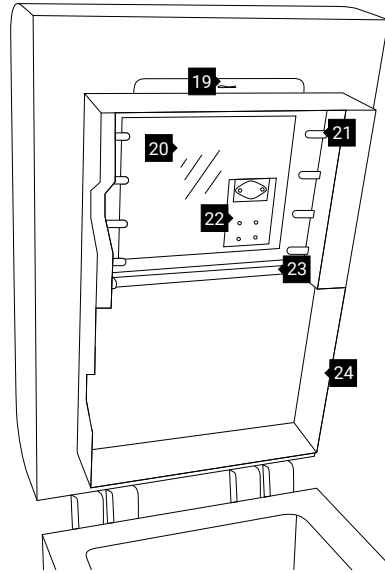

View of the printer Heating module.
 19.Split pin / 20.dedicated place for Laser Protective Glass / 21.Short Infrared heaters (white) four psc. on each side /
 22.Laser module / 23. Long infrared heaters (red) /
 24.Heating module

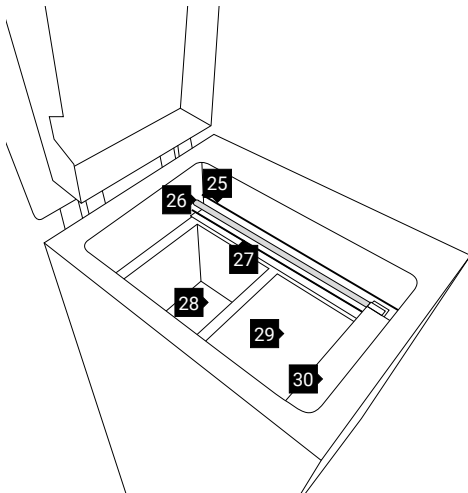

Front view of the printer's Print Chamber.
 25.Recoater drive unit cord / 26.Recoater guide bar / 27.Recoater
 cord / 28.Feed Bed / 29.Print Bed / 30.Recoater

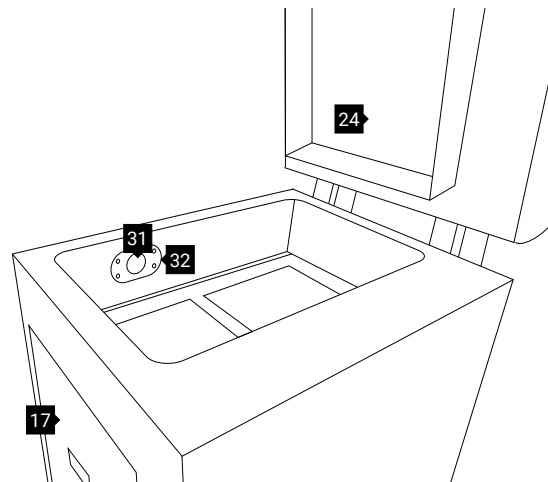

Back view of the printer's Print Chamber.
 31.Embedded camera (for Print Bed) /
 32.Print Bed pyrometer behind Pyrometer Window Module

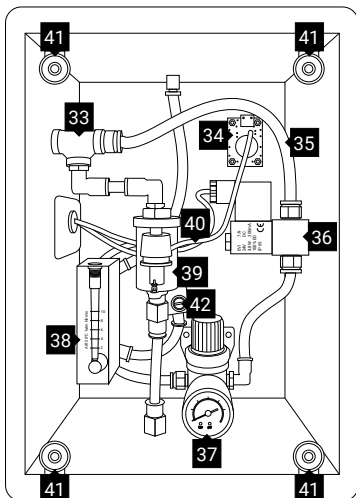

View of the chamber with nitrogen installation.
 33.T-type push-in fitting with a pressure sensor /
 34.Oxygen level sensor / 35.Pneumatic tubings /
 36.Pneumatic solenoid valve /
 37.Pressure regulator with built-in manometer /
 38.Rotameter / 39.Filter air dehydrator / 40.Cable /
 41.Magnetic fasteners / 42.Throttle-return valve



B. SPECIFICATION

GENERAL	
Technology	SLS
Laser system	IR Laser Diode 5 [W] ; λ =808 [nm]
Dimensions	690 x 500 x 880 [mm] (27.1 x 19.7 x 34.6 [in])
Weight	90.0 [kg] (198 [lbs])
PRINT VOLUME	
Max size of print diagonally¹	PA - 301 [mm] (11.8 [in]) TPU / TPE - 313 [mm] (12.3 [in])
High accuracy max print volume	PA - 110 x 160 x 230 [mm] (4.3 x 6.3 x 9 [in]) TPU / TPE - 110 x 160 x 245 [mm] (4.3 x 6.3 x 9.6 [in])
PRINTER PARAMETERS	
Size of Print Bed	150 x 200 x 260 [mm] (5.9 x 7.9 x 10.2 [in])
XY accuracy	from 0.05 [mm] (0.002 [in])
The layer height Z (min - max)	0.075 - 0.175 [mm] (0.003 - 0.007 [in])
PRINT FEATURES	
Min. wall thickness	from 0.4 [mm] (0.015 [in])
Min. detail size	from 0.1 [mm] (0.004 [in])
Hole Diameter	from 0.5 [mm] (0.020 [in])
Moving Part Clearance	from 0.2 [mm] (0.008 [in])
ADDITIONAL PRINTER FEATURES	
Nitrogen chamber	Built-in
Coupling installed in Lisa Pro	Pneumatic quick-coupling Male Plug Nipple DN7.2
Average Nitrogen consumption	0.48-0.54 [m ³ /hour]
SOFTWARE	
Software²	Sinterit Studio 2019 Open
Supported file types	STL, OBJ, 3DS, FBX, DAE, 3MF
OS compatibility	Microsoft Windows



COMMUNICATION	
LCD screen	Capacitive, color
Touchscreen	7 [in]
On-board camera	Built-in
Connectivity	Wifi, USB port
HEATING SYSTEM	
Independent	Heated: piston, cylinder, Feed bed, Print bed
Max. temperature in the chamber	200 [°C] / 392 [°F]
POWER	
Operating Voltage	220-240 [V] AC, 50/60 [Hz], 7 [A] or 100-130 [V] AC, 50/60 [Hz], 15 [A]
Average power consumption	1.1 [kW]
Maximum power consumption	1.9 [kW]
PACKAGING	
For the transportation of a printer we use dedicated protective packaging. Ask for more information.	
Size of package	725 x 635 x 1020 [mm] (28.5 x 25.0 x 40.2 [in])
Package weight	117 [kg] (257.9 [lbs])
WARRANTY	
Warranty	One year limited warranty



6. Preparing the Lisa PRO printer to work after delivery

A. FIRST STEPS

1. REMOVE THE PROTECTION FOIL FROM THE NITROGEN CHAMBER

Grab the Nitrogen chamber handle, pull hard and open it.

Remove the protective foil from the lid. Check for damage inside the chamber. Close the Nitrogen chamber.

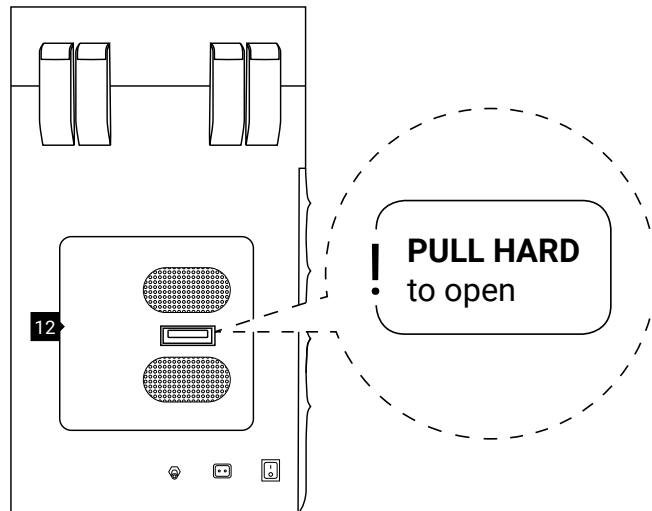

The Nitrogen installation chamber.

2. REMOVE THE "STARTUP BOX" FROM THE SERVICE AREA UNDER THE BEDS

Remove the protection foil with the information „STARTUP BOX in service area“ and remove the box from the service area underneath the BEDs **18**.

Never put objects there! This is the service area of the printer.

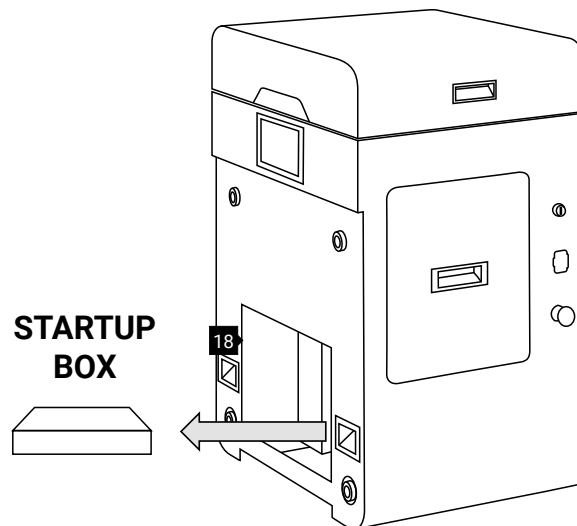

The STARTUP BOX is located in the service area under the BEDs.

3. FIND THE REMOVABLE FRONT PANEL

The Removable Front Panel is located in a recess under the lid of a Flightcase **A**.

Unlock the locks of the Flightcase's lid **F** (one on the right and one on the left side of the top of Flightcase). The locks of the lid open the same way as the locks of Flightcase's cover.

Lift the Flightcase lid by 90 degrees. Inside there should be the Removable Front Panel of the Lisa PRO printer **1**. Lift up the panel.

Look out, it's heavy!

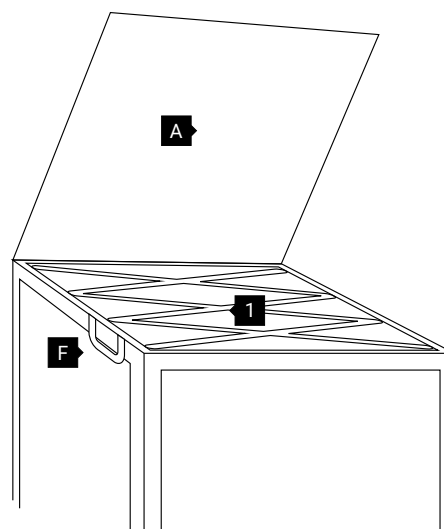

The raised lid of the Flightcase and showing recess with Removable Front Panel for Lisa PRO.



4. INSTALL THE REMOVABLE FRONT PANEL

Holding the Removable Front Panel **1** parallel to the printer, mount it using the four Magnetic fasteners **16** at the front.

After installing the Removeable Front Panel, check that each of the four Magnetic fasteners is connected (pull gently towards you).

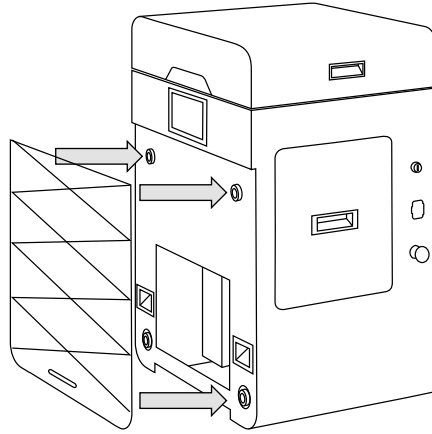

Correct mounting of the Removable Front Panel with the Magnetic fasteners.

5. CONNECT THE POWER CABLE AND TURN ON THE PRINTER

Remove the Power cable **H** from the STARTUP BOX. Connect the Power cable to the printer's Power socket **14** and then to the power supply.

Switch the Power switch (from "0" to "1") located on the left side of the printer **15**.

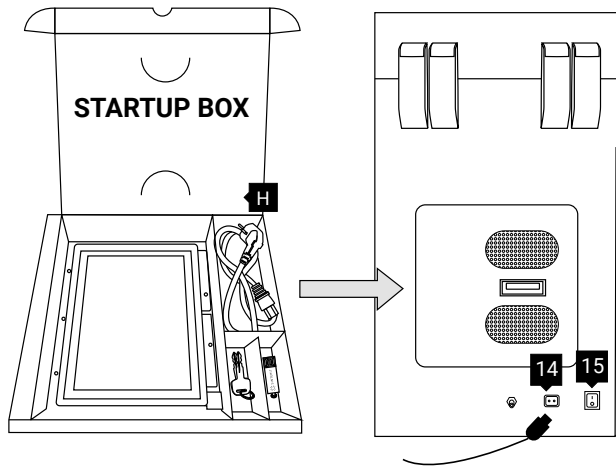

The Power socket and the Power switch are located on the left side of the printer.

6. CHECK THE SAFETY BUTTON

Check whether the Safety button (red button on the right side of the printer) **10** is out. If not, rotate the black flange of the button clockwise at a quarter of a turn.



Unlocking Emergency Stop Button.

7. TURN THE PRINTER ON WITH THE IGNITION KEY

Place the Ignition key **1** in the Key slot **9** and turn it clockwise at a quarter of a turn.

Please wait until the main menu with four buttons appears on the LCD screen (it takes about 20 seconds).

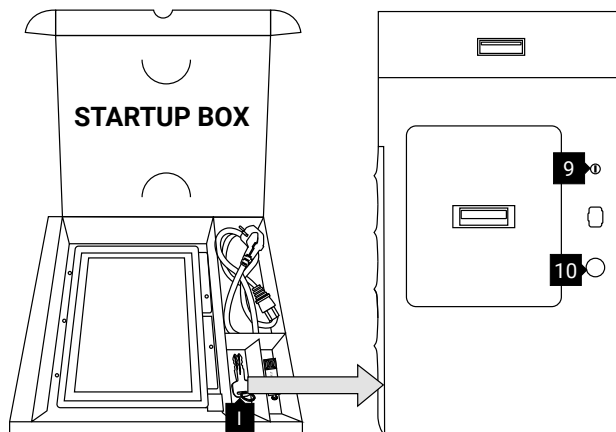

The Safety Button and Key slot are located on the right side of the printer.

Remember to register your printer and remove the sticker from the screen.



8. UNLOCK THE OVERFLOW BIN AND REMOVE THE PROTECTION FOIL FROM IT

Attention, Electrolock! To unlock the Overflow Bin **7** press UNLOCK LID/OVERFLOW BIN button on the screen **2**. The magnetic blockade deactivates for 10 seconds. After 10 seconds, it will re-activate.

Grab the Overflow Bin handle, pull and open it. Remove the protective foil from the lid. Put the Overflow Bin back in.

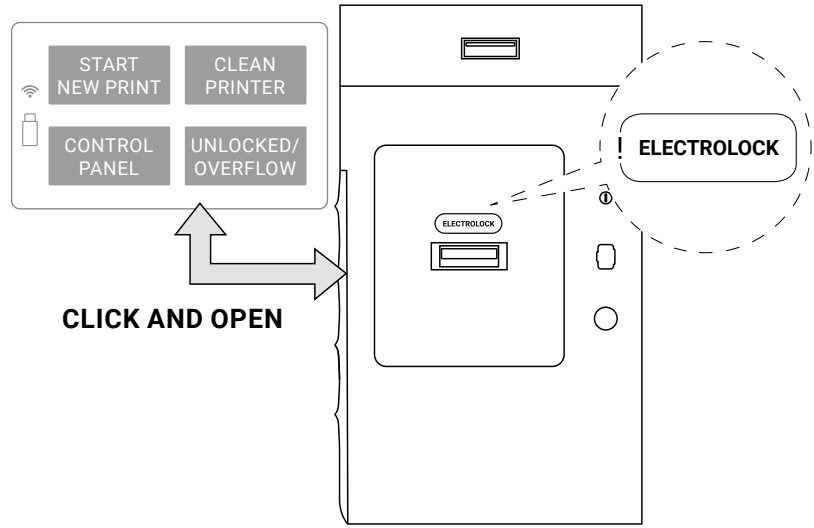

Unlocking the Overflow Bin.

9. OPEN THE PRINTER'S LID AND REMOVE THE SECURITY FEATURES FROM THE INSIDE

Attention, Electrolock! To open the printer's lid **5** press UNLOCK LID/OVERFLOW BIN button on the screen **2**. The magnetic blockade deactivates for 10 seconds. After 10 seconds, it will re-activate.

Softly press the lid and then lift it using Lid's handle **6**.

Be careful! The lid is quite heavy!

Remove the protection from the printer's inside.

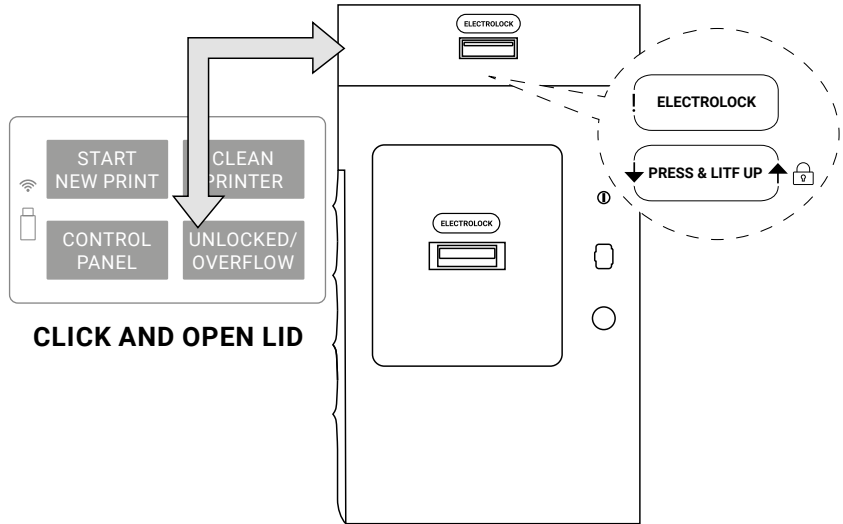

Unlocking the printer Lid.



CAUTION!

Beware of sharp edges. Put on Protection Gloves to protect yourself from injuring hands against the edge of the Heating module. The Protection Gloves are included in the plastic bag ("Personal Protection" kit) with the Advanced Accessories.

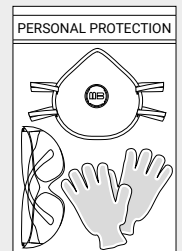



10. REMOVE THE PLASTIC PROTECTION CAP FROM THE HEATING MODULE

We recommend to turn off the power of the device (turn off the Ignition key **9**, **11**).

While holding the Heating module **24**, take out the Split pin **19** positioned on the top of the inner part of the Lid **5**.

Lower the Heating module to get access to the place dedicated to the Laser Protective Glass **20**.

Remove the Plastic Protection Cap of the Laser Protective Glass module and save it (we recommend keeping the Plastic Protection Cap in the Flightcase).

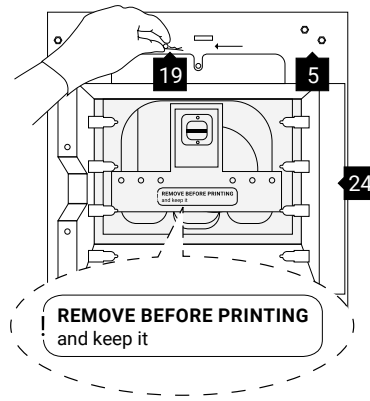

Heating module – removing the Split pin.

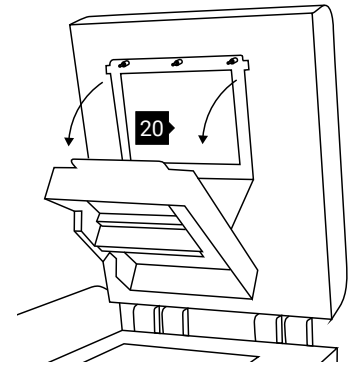

Heating module – opening.

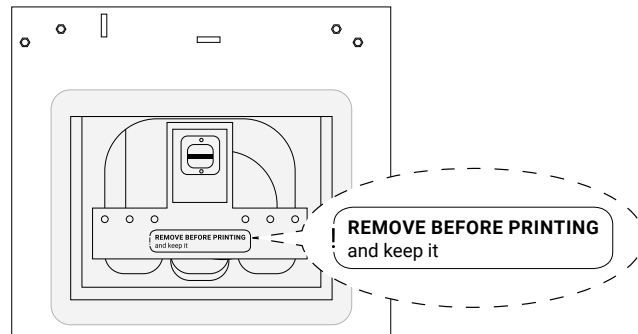

View on the Plastic Protection Cap of the Laser module.

Now you can install the Laser Protective Glass **G**.

B. INSTALLING THE LASER PROTECTIVE GLASS

1. REMOVE THE LASER PROTECTIVE GLASS FROM THE „STARTUP BOX” AND CLEAN IT

Don't throw out the STARTUP BOX. Put it in Flightcase.

Rub the surface of glass carefully with a cotton cloth soaked with 2% salicylic spirit (ethanol solution) or any other ethanol-based solution. Do not use isopropyl alcohol! Pay attention to any fibres left on the surface. Clean both sides.

Remember to wipe the Laser Protective Glass with a dry piece of cloth afterwards.

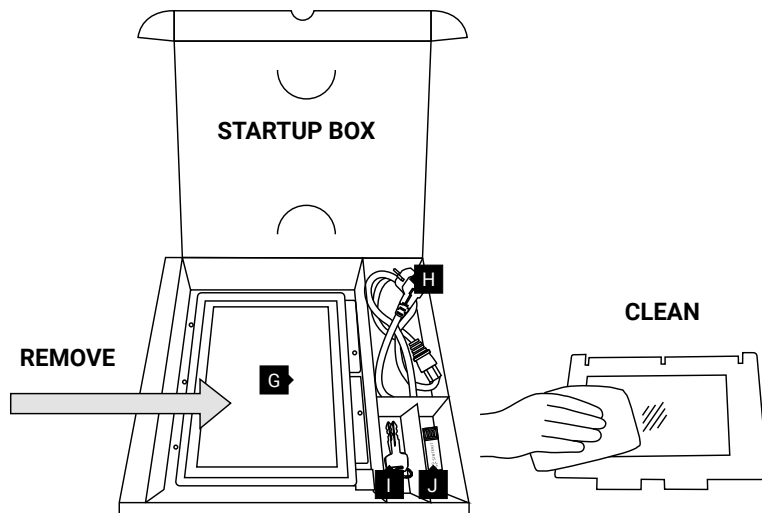

Remove and clean the Laser Protective Glass.



2. MOUNT THE LASER PROTECTIVE GLASS MODULE

Slide the metal tabs of the Laser Protective Glass module into the holders located in the middle of the Lid.

Press the gasket gently. After obtaining the perfect fit, screw the two Quick release nuts on to the visible screws.

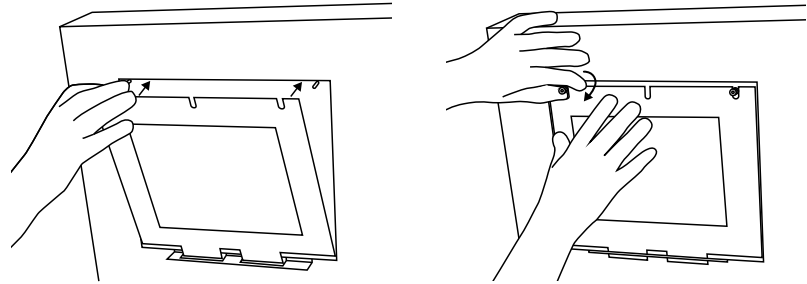

Correct placement of the Laser Protective Glass on the Heating module.

3. CLOSE THE HEATING MODULE

Join the Heating module with the Lid using the metal Split pin.

Clean the Laser Protective Glass one more time from any finger marks or stains if present.

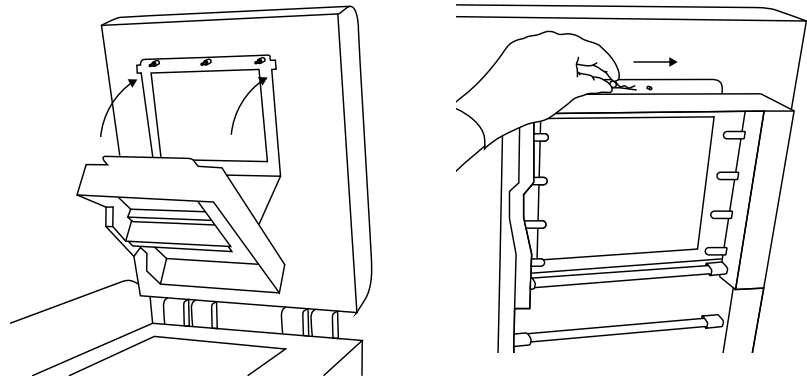

Correct closing of the Heating module.

C. CONNECTING THE PRINTER TO WI-FI NETWORK

1. TURN ON THE PRINTER AGAIN

Switch the Power switch (from "0" to "1") and next place the Ignition key in the Key switch and turn it clockwise at a quarter of a turn.

Please wait until the main menu with four buttons appears on the LCD screen (it takes about 20 seconds).

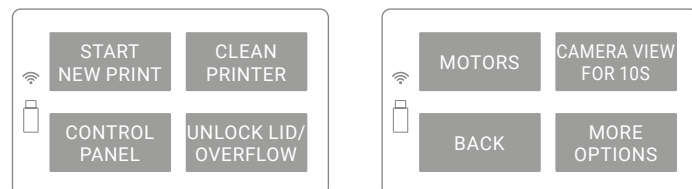

2. FIND THE WI-FI BUTTON

To connect to the Wi-Fi network, press the CONTROL PANEL button. Next one MORE OPTIONS button and then the WI-FI button.

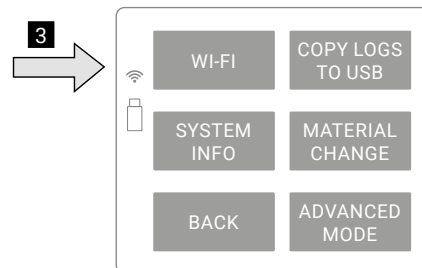

Step by step connection to Wi-Fi.

3. CONNECT TO YOUR WI-FI NETWORK

Find the network you want to connect to and click on its name. Enter your password if necessary and press OK.



4. WI-FI ACTIVATION

The highlighted Wi-Fi icon in the upper left corner means a network connection.

Press the BACK button to return to the main menu screen.

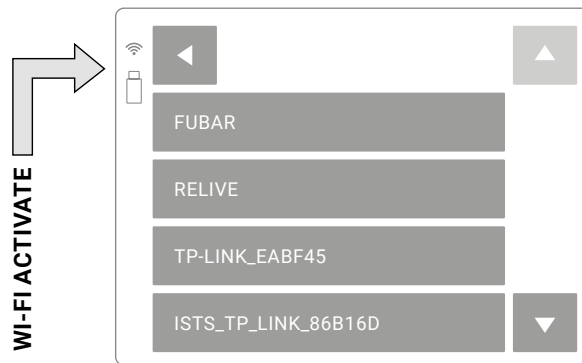

The sign in the upper left corner of the screen shows active Wi-Fi.

D. LAST STEPS BEFORE START PRINTING

1. CHECK FIXING THE SHORT INFRARED HEATERS IN SOCKETS

Check (wearing gloves or through the paper) whether the Short Infrared Heaters are stable in their sockets (8 pcs.).

If there is any dust/powder on them, blow it gently off with air.

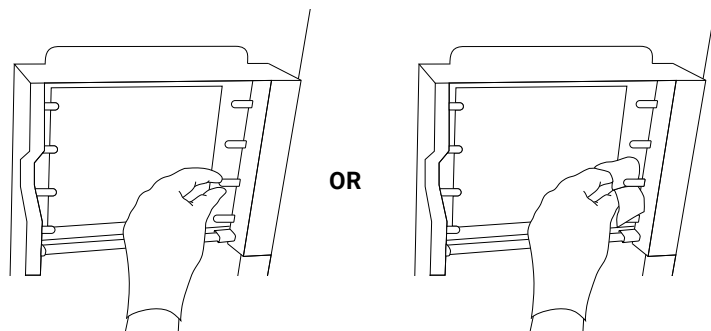

Methods of verifying the correct seating of Short Infrared Heaters.



ATTENTION!

Remember, do not touch the Short Infrared heaters with your fingers or greasy objects (eg. a dirty cloth).

Dirt and grease may cause local overheating and burn the heaters or even cause an explosion during printing.

2. CHECK THE ELEMENTS IN THE PRINT CHAMBER

Verify whether the Feed Bed **28** and Print Bed **29** are ready to work (after unpacking the BEDs should be on par with the printer's case), check the Recoater's cords **25**, **27** tension and whether the Recoater's guide bar **26** is clean.

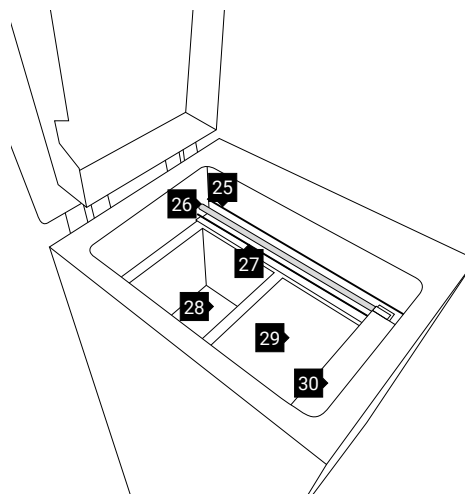

Check the parts in the Printing Chamber.

After carrying out all of these steps, the printer is prepared to work.



7. Main menu - what, where, how? Short explanation of functions.

- **START NEW PRINT** - Button allowing to prepare the printer for printing.
- **CLEAN PRINTER** - A button allowing you to go through the process of removing the printout and cleaning the printer.
- **CONTROL PANEL** - Button to access advanced functions (explained below).
- **UNLOCK LID/ OVERFLOW** - The button releases for 10 seconds the electrolock of the printer Lid and/or Overflow Bin. Only after pressing this button is it possible to open the printer lid or remove the Overflow Bin.

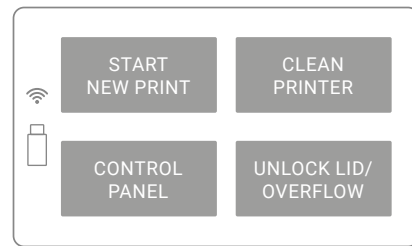

Main Menu screen.

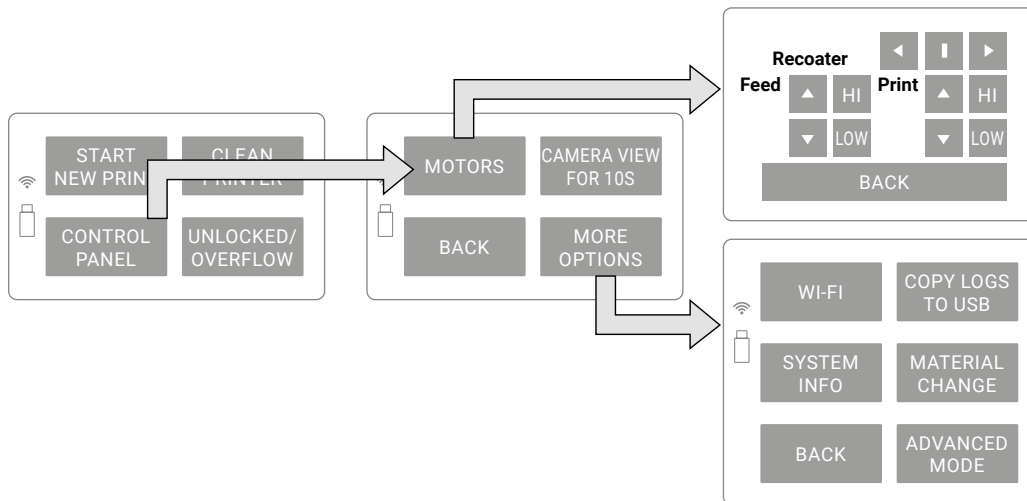

Available options and processes are hidden under the CONTROL PANEL button.

In the CONTROL PANEL menu you can find:

- **MOTORS** - This function allows you to manually move the Recoater and Bed's. It also allows for automatic homing of the Recoater and the Beds to the starting positions.
- **CAMERA VIEW** - the button activates the camera on the Print Chamber for 10 seconds.
- **BACK** - returns to the main menu
- **MORE OPTIONS:**
 - **WI-FI** - Connection of the printer to the Wi-Fi network.
 - **SYSTEM INFO** - Screen showing basic information about the printer (model, revision, software version, serial number, IP number).
 - **COPY LOGS TO USB** - The button allows you to copy the logs from the printer to the USB flash drive (and e.g. send to the Sinterit Support in case of problems).
 - **MATERIAL CHANGE** - The process helps the user, step-by-step, through the safe exchange of powder with different melting temperatures, e.g. from FLEXA to PA12.
 - **ADVANCED MODE** - A screen that allows you to switch to an advanced version of the printer software. A more detailed explanation is available in a dedicated chapter.

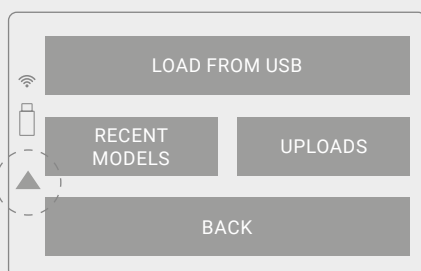





IMPORTANT!

Yellow triangle displayed on the side of the screen informs about a malfunction.

Please contact the Support Team by referring to the code displayed inside the warning triangle and providing the serial number of the device.

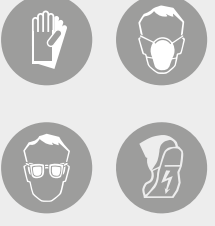

8. Printing - simple mode

	<p>ATTENTION!</p> <ul style="list-style-type: none">• Before starting any work with powder, always wear adequate protective clothing, eyewear, face mask, and gloves.• A suitable set is included in the DEDICATED POWDER TOOLS for Lisa PRO printer as PERSONAL PROTECTION kit.
	<p>CAUTION!</p> <p>Beware of sharp edges, especially on the Lid.</p>
	<p>IMPORTANT!</p> <ul style="list-style-type: none">• The system will guide you step by step through the printing process.• Please read the messages on the LCD screen carefully. Skipping the described operations may result in incorrect printing or machine failure.• The BACK button takes you back to the previous screen (if you missed something by accident or want to take a step again).
	<p>IMPORTANT!</p> <ul style="list-style-type: none">• For the first use of the Sinterit Lisa PRO printer with PA12 Smooth or PA11 Onyx, please use only the powder from the container labelled STARTER POWDER.• The process of mixing powders will be described in a separate chapter.

1. Check whether the Safety button (red button on the right side of the printer) **10** is out. If not, rotate the black flange of the button clockwise at a quarter of a turn.
2. Turn on the printer. Switch the Power switch **15** from "0" to "1" and turn the Ignition key in the Key slot **9** clockwise at a quarter of a turn.
3. Please wait until the main menu with four buttons appears on the LCD screen (it takes about 20 seconds).

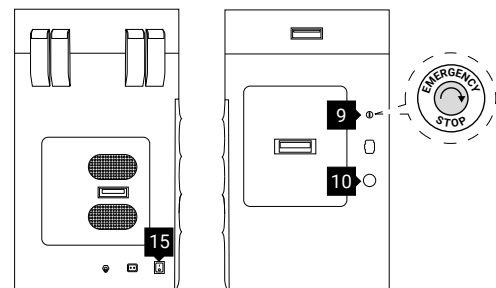

Unlocking and turning on the printer.

4. Attention, Electrolock! To open the printer's Lid **5** press START NEW PRINT/UNLOCK LID button on the screen **2**. The magnetic blockade deactivates for 10 seconds. After 10 seconds, it will re-activate.
5. Softly press the Lid and then lift it using Lid's handle **6**.
Be careful! The Lid is quite heavy!
6. Check that all components are in place, ready to be filled with powder.

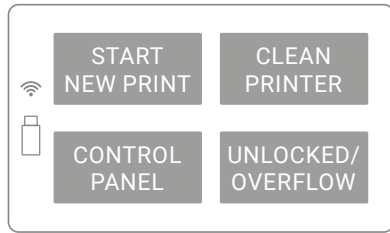

Main menu screen.

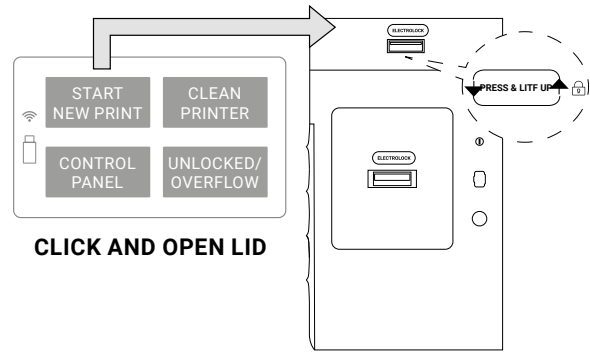

Unlocking the printer Lid.

- The printer will ask you if you have cleaned the powder after the last printout.
 - If yes, press the YES button,
 - If not, then NO, THE POWDER IS STILL INSIDE button - the cleaning process will start. The following steps are described in the chapter „Finishing the print“.
 - This message will not appear when you print the first time after delivery.

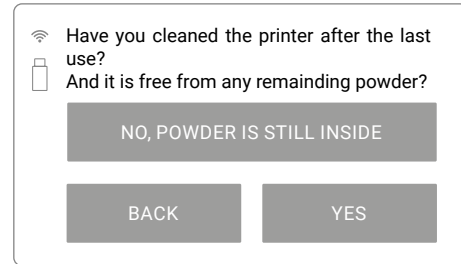

Message about cleaning the printer after previous printing.

- Prepare the file with the xxx.scode extension in Sinterit Studio.
- The prepared xxx.scode file can be sent directly to the printer (when connected to a Wi-Fi network) or uploaded via USB Flash Drive.

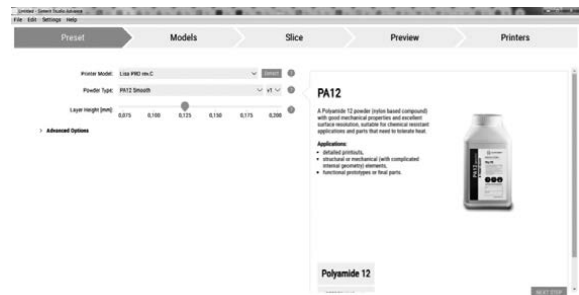

Prepare the file in the Sinterit Studio.

- Select the file for printing. You have several options:
 - LOAD FROM USB - when the file is saved on the USB Flash Drive,
 - UPLOADS - when the file was sent via Wi-Fi,
 - RECENT MODELS - when the file is in the internal memory of the printer.

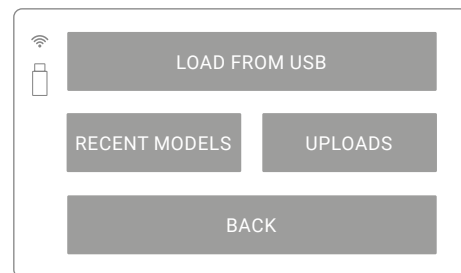

Select the file source.

- Select a file from the list and click on it. The file name, printing time and the type of powder to use will appear on the screen.
- Prepare a suitable powder and press the NEXT button.

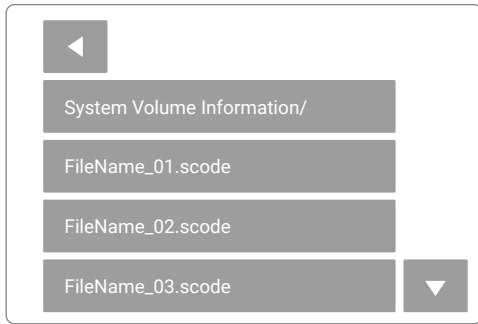

Select the file to print.

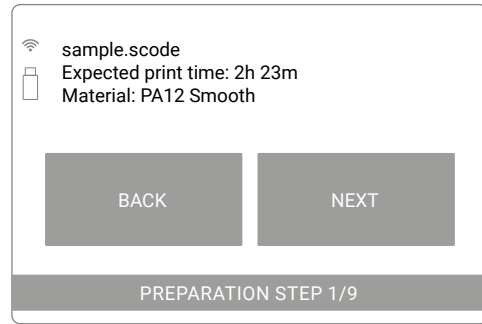

Basic information after loading the file to the printer screen

13. Check that the way of the Recoater **30** is not obstructed. If not, confirm with the "DONE" button. The Recoater and the Beds **28**, **29** will be homing:
 - The Recoater **30** will be positioned over the Overflow Bin gap,
 - Print Bed **29** will level with the Print Chamber,
 - Feed Bed **28** will be set to a height corresponding to the volume of the powder for printing needed.

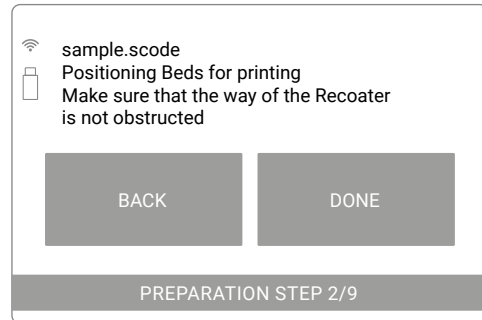

Check the Recoater's path.

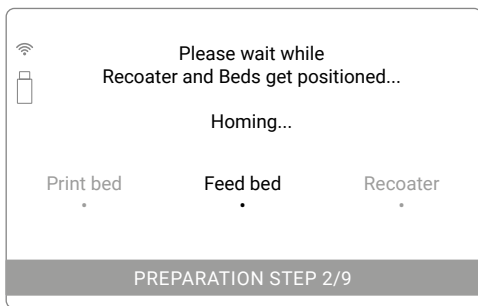

Beds and Recoater's homing screen.

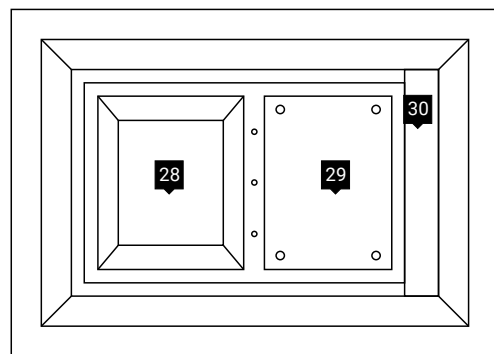

View of the Print Chamber after the positioning of Beds and Recoater.

14. Prepare the IO Box. After positioning the Beds and Recoater, insert the IO Box into the Print Chamber as the presented opposite.
15. We recommend first to insert the folded IO Box into the Print Chamber and then spread them out to the width of the Print Chamber. Be careful of the elements inside the Print Chamber and on the Lid.
 - The IO Box allows you to pour the powder cleanly into the Feed Bed. Other elements of the Print Chamber (e.g. the Pyrometer Window Module, the Recoater guide bars) will be clean and the start of the printing will be faster.

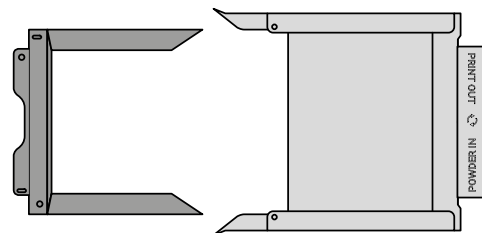

Correct position of the elements of the IO Box to pour the powder into the Feed Bed.

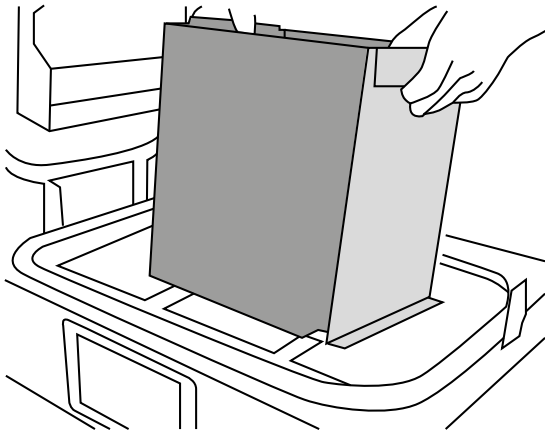

Insert the folded IO Box into the Print Chamber...

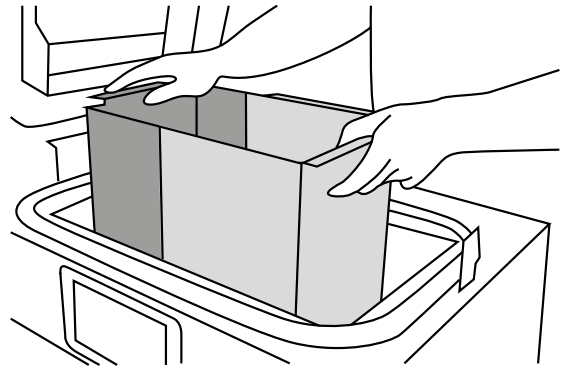

...and then gently slide it apart.

16. Using the Powder Funnel, fill the Feed Bed with powder. The required volume of the powder is given in the report in Sinterit Studio.

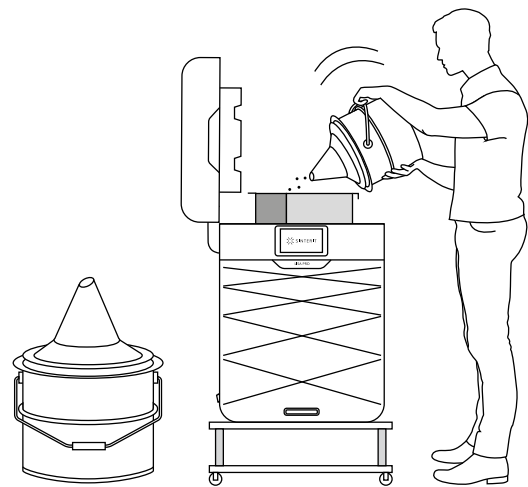

**Pour the powder into the Feed Bed.
Use the Powder Funnel.**

17. Gently compress the powder in the Feed Bed. We recommend using the Trowel - its size corresponds to the size of the Feed Bed.
18. Take out the IO Box from Print Chamber. Be careful not to damage the Lid components.

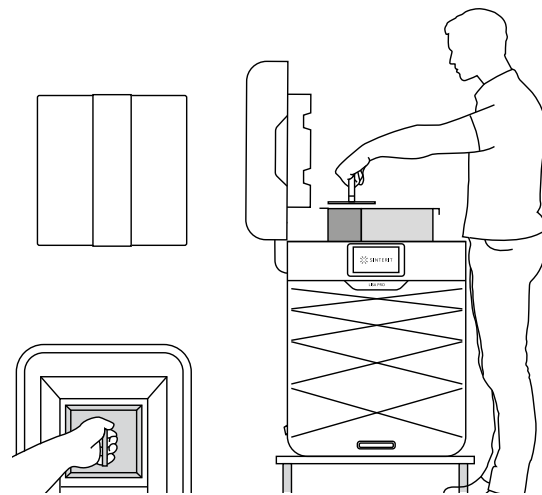

**Compress the powder in the Feed Bed.
Use the Trowel.**

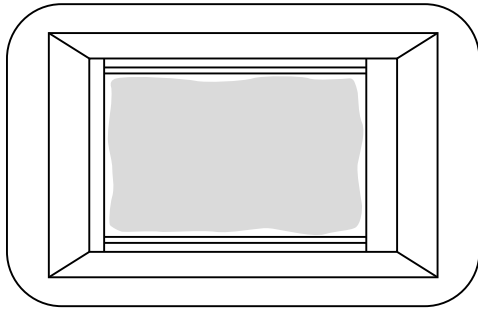

Pour a bit of powder into the Print Bed.

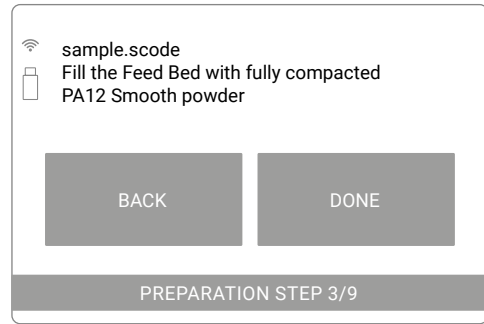

Process screen: fill up the Feed Bed with powder.

- 19. The powder will be automatically levelled. Press **START LEVELING** to start.
- The process will be automatically stopped when the powder layer reaches a few millimeters thickness on the Print Bed.

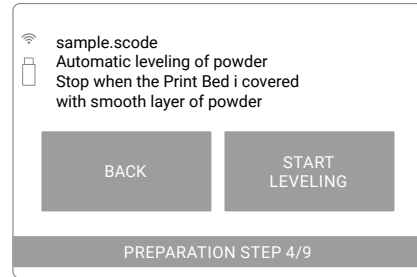

Press **START LEVELING to start levelling off the powder in the Print Chamber.**

- 20. If the powder has been thoroughly distributed over the entire Print Chamber (especially Print Bed), the levelling process can be stopped, by pressing the **STOP LEVELING** button on the screen.

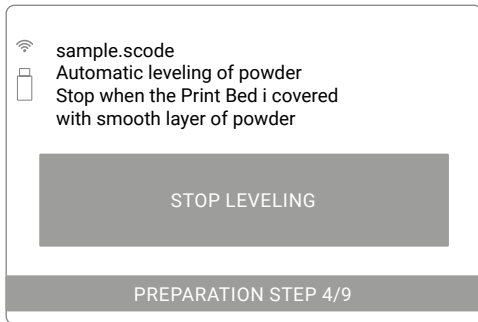

Press **STOP LEVELLING - when the powder has been distributed throughout the Print Chamber.**

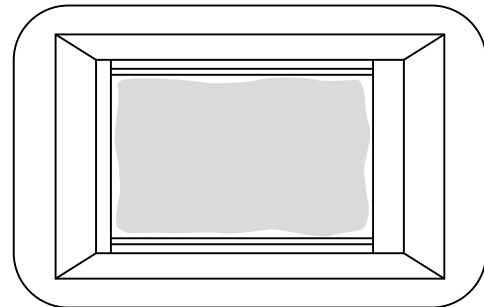

View of the Print chamber after correct powder levelling.

- 21. If the powder layer is ok, press the **NEXT** button.
- If the quality of the created layer, after levelling, is not satisfying, you can repeat the process by clicking on the **REPEAT LEVELING** button.

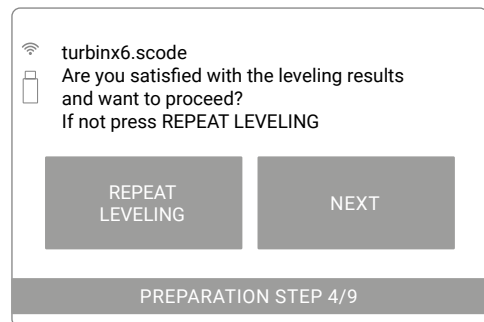

Is the spreading of the powder satisfactory or repeat the process?



22. Remove, clean and then re-insert the Laser Protective Glass **G**. Then press the DONE button.
- The complete cleaning process is described in the section „Maintenance and daily service of the Sinterit Lisa PRO printer”, subsection „Laser Protective Glass - cleaning and replacing”. Chapter 16, subchapter B.
 - Remember to use only products with an ethanol-based solution for cleaning! We recommend using the Alcohol Pads from the Service Kit.
 - Other products (e.g. isopropyl alcohol) can destroy the Laser Protective Glass.

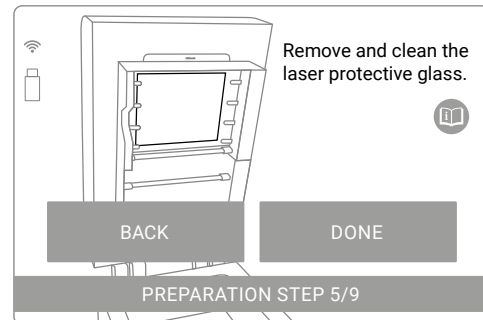

Remove, clean and then re-insert the Laser Protective Glass.



STOP!

- Watch out for the elements of the Heating module **24** of the device.
- Do not clean the Laser Protective Glass **G** under running water.
- The cleaning process should be carried out outside of the machine.

23. Gently clean the Pyrometer Window Module **32**. We recommend using the Alcohol Pads from the Service Kit. Wipe to dry and press the DONE button.

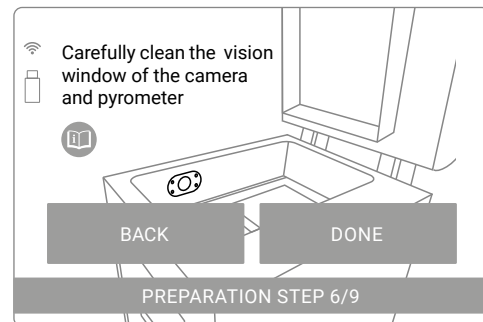

Clean the Pyrometer Window Module.

24. Clean the Recoater Guide Bar **26**. We recommend using Alcohol Pads or a cotton cloth soaked in ethyl alcohol. Press the DONE button.

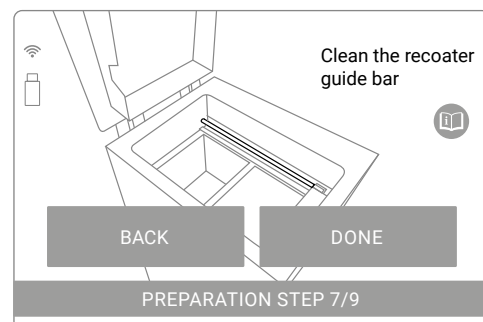

Clean the Recoater Guide Bar.

25. After wiping the Recoater Guide Bar with alcohol, oil it with silicone oil (available in the Service Kit). A few drops are enough. Then press the DONE button.

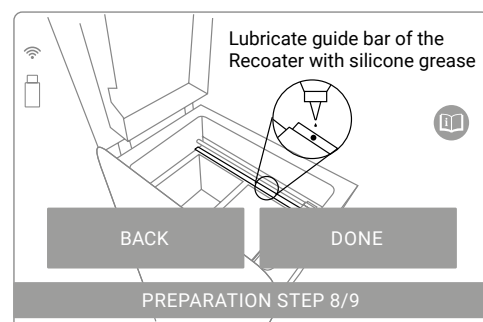

Lubricate the Recoater Guide Bar with silicone oil.



- 26. Check that there are no unnecessary elements in the Print Chamber. If not, close the printer Lid.

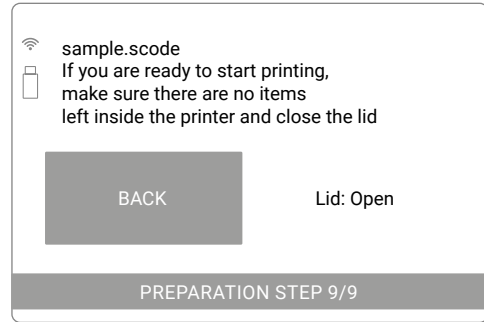

Check the Print Chamber and close the Lid.

- 27. The printer is ready to print. Press START PRINTING to start the process.

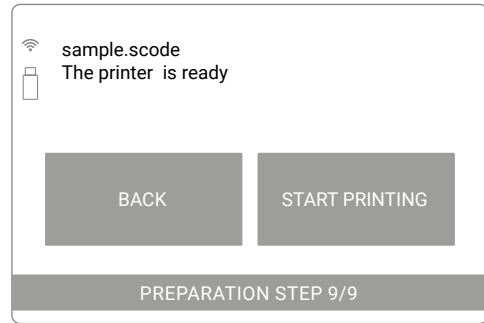

Press START PRINTING to start the printing process.

9. Information and tasks while printing

- 1. The printing process is divided into 3 steps: heating, printing and cooling down. The actual, active step is shown on the screen (bold).
- 2. The screen displays all important information for the user: the file name, the active step, the process done in percentage, the remaining time.
- 3. If you want to see the view from the internal camera, press CAMERA VIEW. The view will be displayed for 10 seconds. After that, the display will return to the main screen.

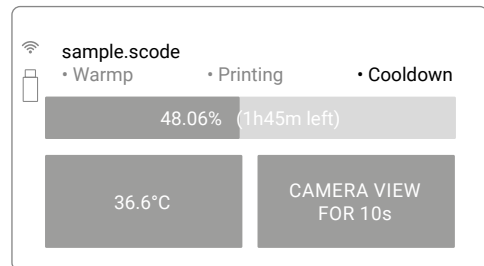



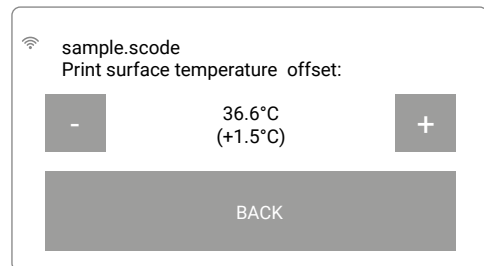
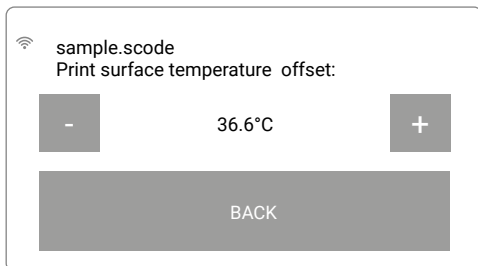

The main screen during printing.

- 4. During printing, if there are any visible problems observed by the internal camera or the upper Viewing window, the user can precisely change the temperature by pressing the button on the left (shows the current temperature inside the printer). The next window allows you to change the temperature.









Screen for temperature change during printing (before and after change).



 	<p>Temperature management suggestions</p> <ul style="list-style-type: none">• The possibility to adjust the temperature is also provided in the Sinterit STUDIO software.• On the machine, this option is depicted using + and – buttons which increase or decrease the temperature by 0.5 [°C] (maximum extent +/- 5 [°C]). In Sinterit STUDIO, this option is depicted using PRINT SURFACE TEMPERATURE Offset drop-down menu [°C].• These options are used to increase the level of cake welding (printouts more straight but less detailed) or to decrease the level of cake welding (cake becomes more powdery, it is easier to clean it up but printouts can be distorted; printout details have better quality).• Another calibration option is to change the laser power. This change is only possible on the level of Sinterit STUDIO. In the program menu, it can be found as LASER POWER RATIO (1.0 by default).• The laser intensity is raised by increasing the value by 0.01 and lowered by decreasing (also by 0.01). The acceptable calibration scope of laser multiplier is 0.5-3.0.• As the laser gets weaker, the printout durability gets lower as well, however, the quality of details gets better. Similarly: an increase of laser power strengthens the printout but weakens the quality of details. <p>These remarks apply to the polyamide materials (e.g. PA12 SMOOTH and PA11 ONYX). In case of FLEXA materials, an increase in laser power results in a printout stiffening (up to a certain, maximum level).</p>
	<p>ATTENTION! Do not lower the temperature inside too quickly. The permissible standard is 0.5 [°C] on one layer.</p>
	<p>ATTENTION! During printing, if the smoke, irritating smell or other alarming circumstances take place, press the Safety button 10. It will immediately cut off the power from the printer. However, remember that it is impossible to open the printer (e.g.: by lifting the Lid), until the temperature inside will not drop below 50[°C] and the UNLOCK LID option becomes available.</p>
	<p>ATTENTION! While the printer is working do not touch any other elements besides the LCD screen 2, the Safety button 10, the USB port 8 and the Power switch 15.</p>



10. Printing with nitrogen installation

	<p>WARNING!</p> <ul style="list-style-type: none">• The built-in oxygen level detector is not a certified device and the signal cannot be treated as the only warning. Keep the LISA PRO printer and the nitrogen bottle in well-ventilated rooms.• If you hear an alert, open the windows/ventilate the room and leave the room.• If you feel any suspicious symptoms, immediately leave the room and go outside/to a well-ventilated room.	 
	<p>WARNING!</p> <ul style="list-style-type: none">• Store in a well-ventilated place.• Do not inhale the gas.• Possibility of unsealing - gas has a suffocating effect on people by displacing oxygen from the air. Too low oxygen concentration in the air can lead to unconsciousness and death.	 

A. NITROGEN INSTALLATION - MESSAGES AND SOUND SIGNALS

1. If the nitrogen pressure becomes too high or too low, an intermittent sound signal is activated.
2. If the nitrogen pressure is too low, connect a proper nitrogen supply or the printing will stop in 3 minutes.
3. If the nitrogen pressure is too high, a notification is displayed.
4. If the concentration of oxygen in the printer's surroundings is too low, a continuous sound signal is activated.
5. If the oxygen level in the printer's surroundings drops below 17%, a continuous sound signal is activated and the printer displays a message „LOW OXYGEN LEVEL” on the touchscreen.

B. PREPARING INSTALLATION TO PRINT

1. To print in the nitrogen environment (required for PA11), connect the nitrogen supply to the Nitrogen inlet nipple **13**. It can be connected at any time, even when the printer is off, as it has an electrovalve built-in.
2. Make sure that the nitrogen pressure is between 4 and 8 [bar] during the whole process. Remember that it may change if you're using a bottle and a pressure regulator.
3. Start the printing process as usual. If the xxx.scode file is properly prepared, the printer will automatically control the use of the nitrogen chamber.

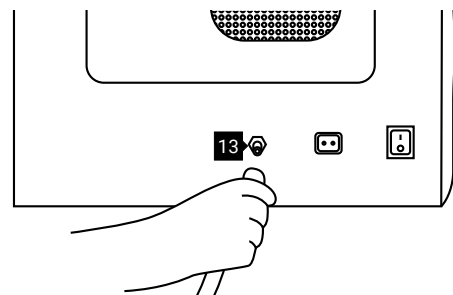

Connecting the pneumatic tube to the Nitrogen inlet nipple on the printer.



11. Finishing the print

A. REMOVING THE PRINTOUT

	<p>ATTENTION!</p> <ul style="list-style-type: none"> • Before starting any work with powder, always wear adequate protective clothing, eyewear, face mask, and gloves. • A suitable set is included in the DEDICATED POWDER TOOLS for Lisa PRO printer as PERSONAL PROTECTION kit.
	<p>IMPORTANT!</p> <ul style="list-style-type: none"> • The system will guide you one by one through the process of pulling the printout and cleaning the printer (next chapters). • Please read the messages on the LCD screen carefully. • The BACK button takes you back to the previous screen (if you missed something by accident or want to take a step again).

1. When the process will be finished, the information of the possibility to remove the printout will be displayed.
 - Clicking the REMOVE PRINT button will start the process of pulling out the printout and redirect to the next steps.
 - Clicking on the MAIN MENU button will cancel the print pullout process and return to the main screen.

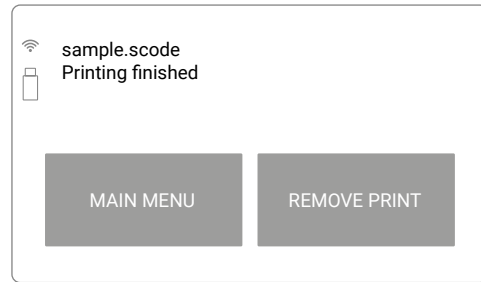

Printing finish screen.

2. Press the "UNLOCK LID" button on the LCD screen to open the Lid.

Remember: The Lid's electrolock deactivates for 10 seconds. After this time, it will re-activate).
3. Softly press the Lid and then lift it.

Look out! The lid is quite heavy.

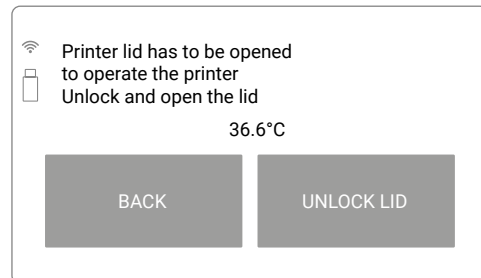

Deactivate the lock to open the Lid.

	<p>IMPORTANT!</p> <ul style="list-style-type: none"> • The blockade of the printer Lid is engaged up until the internal temperature will not drop below 50 [°C]. • There is no possibility to open the Lid before the temperature drops. • Remember that the print inside the printer may still be hot, even though the printer has cooled down! 	
--	--	--



4. Click the REMOVE PRINTOUT button if you want to pull out the printout.
 - If you removed it earlier you can skip this step by pressing the ALREADY DONE button

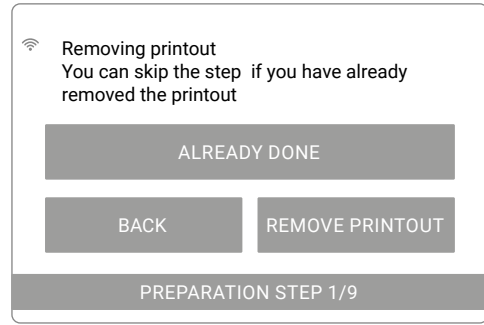

The printout removal screen.

5. Check that the way of the Recoater is not obstructed. If not, confirm with the "DONE" button. The Recoater will be homing.

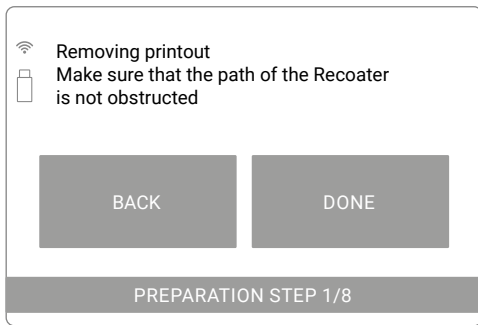

Check the Recoater's path.

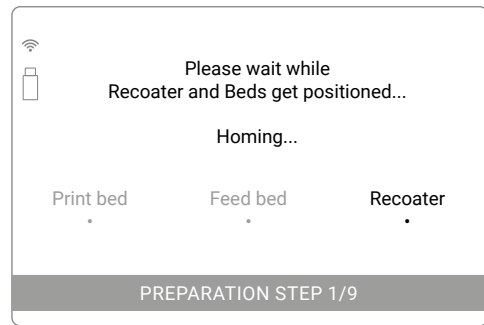

Recoater's homing screen.

6. Prepare the IO Box. You will need it to take out the printout easily and cleanly.

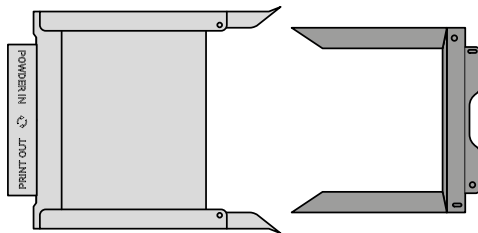

Feed Bed

Print Bed

Correct position of the elements of the IO Box to pull out printouts.

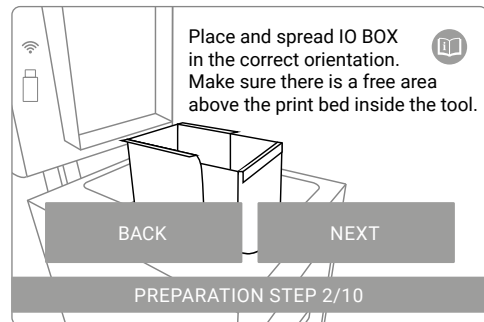

The printer will also help with a suitable screen.

7. Place the IO Box into the Print Chamber as shown above. We recommend first to insert the folded IO Box into the Print Chamber and then spread them out to the width of the Print Chamber. Be careful of the elements inside the Print Chamber and on the Lid.
8. Press the NEXT button.
9. After pressing the NEXT button, the Print Bed is positioned and the printout is ejected.

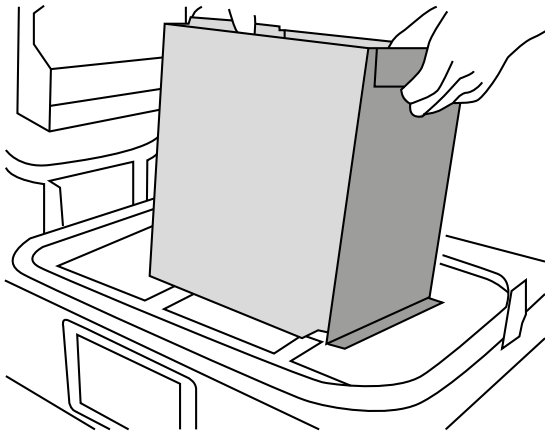

Insert the folded IO Box into the Print Chamber...

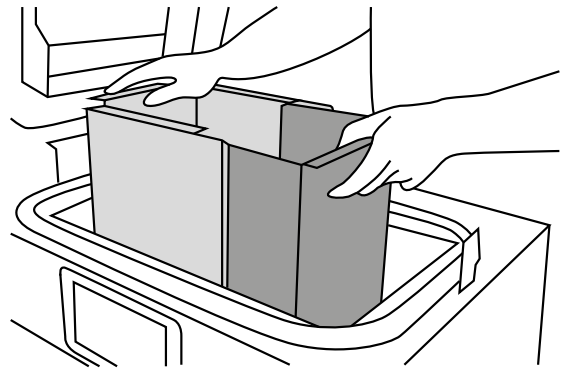

...and then gently slide it apart.

10. When finished ejecting the print from Print Bed, the message **YOU CAN NOW REMOVE THE PRINTOUT FROM THE PRINTER** will appear.
11. Connect both parts of the IO Box (fig. below) and take out the contents of the Print Bed. Then press the **DONE** button on the screen.

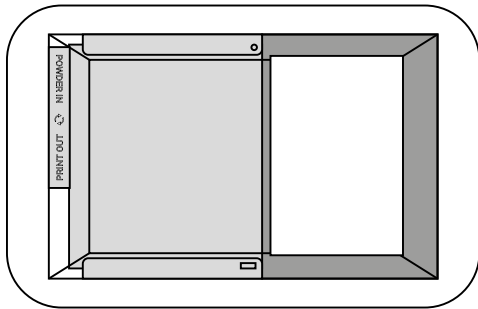

The printout has been ejected into the IO Box and is ready to be removed.

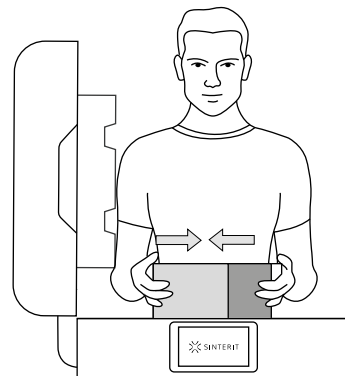

Slide the two IO Box elements together (with the printout inside) and take it out.

12. The IO Box with its contents can be transferred to Foldable Tray or a PHS worktop.

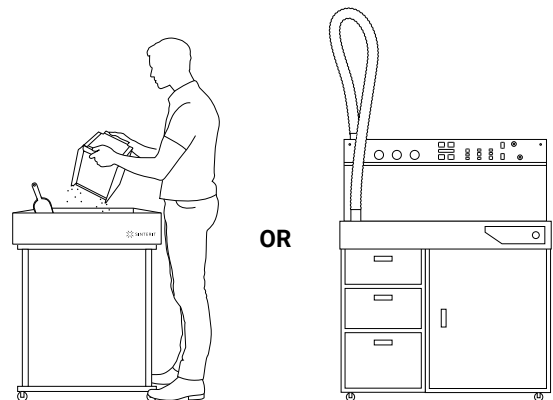

Place the printout on the Foldable Tray or PHS worktop.

13. There is still powder in the printer, both in the Print Chamber and the Overflow Bin. It must be removed.
14. At this step, do not transfer the powder from the Print Chamber to the Overflow Bin (through the Overflow Bin gap) because it may be full.
15. Remove the powder from the Overflow Bin. To do this, press **UNLOCK OVERFLOW BIN** on the next screen. The magnetic blockade deactivates for 10 seconds. After 10 seconds, it will re-activate.
16. Remove the Overflow Bin from the printer and transfer its contents to Foldable Tray or PHS worktop.
17. Insert the Overflow Bin in its place and press the **DONE** button.

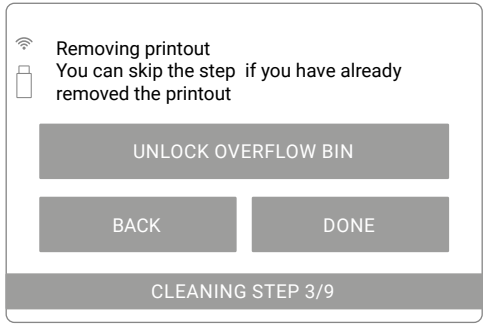

Overflow Bin unlock screen.

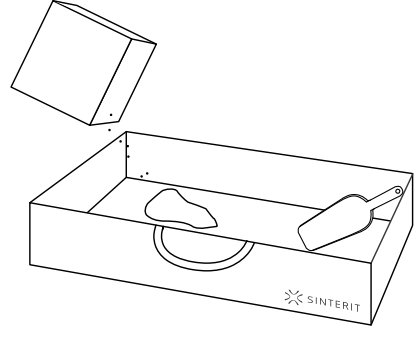

Take out the Overflow Bin and pour out its contents on the Foldable Tray or PHS worktop.

The next steps are cleaning the printer. This can be done in two ways:

- using the PHS device or Sinterit ATEX Vacuum Cleaner with Powder separator (we recommend),
- manually.

Depending on the selected method, the cleaning process will differ. Therefore, a screen with a choice of options will appear on the printer screen.

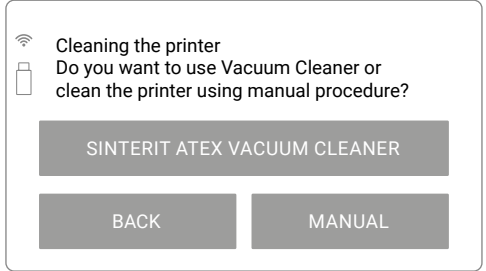

Screen to choose the method of cleaning the printer: manual or with ATEX vacuum cleaner.

B. CLEANING THE PRINTER USING THE PHS DEVICE, SINETRIT ATEX VACUUM CLEANER OR CLEANING SYSTEM

Using a vacuum cleaner is an easy and quick way to remove all remaining powder in the printer. Thanks to this, the printer is ready to reprint right away. For this process, you can use either the Sinterit Cleaning System (ATEX Vacuum Cleaner with Powder Separator) or the Sinterit Powder Handling Station (PHS).

Sinterit Powder Handling Station (PHS)

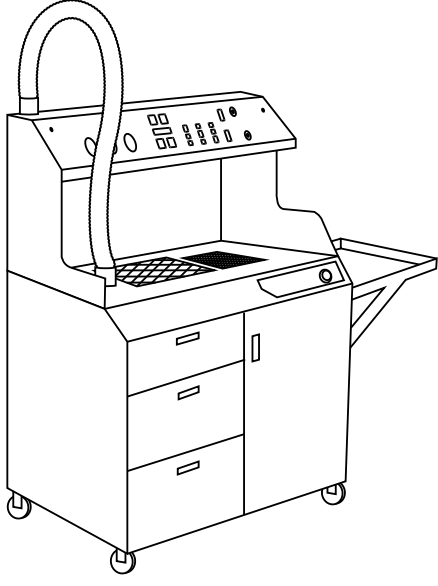

Sinterit Cleaning System

OR

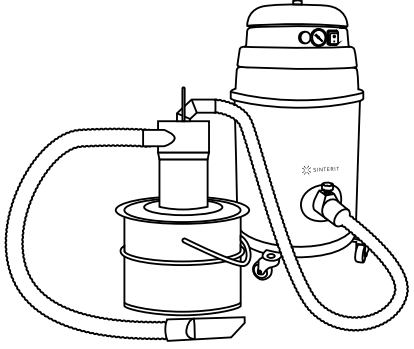



1. After pressing the SINTERIT ATEX VACUUM CLEANER button the cleaning process of the printer will start.
2. Check that the way of the Recoater is not obstructed and press the DONE button.
3. The Print Bed will be lowered and the Recoater will set up between the Beds.

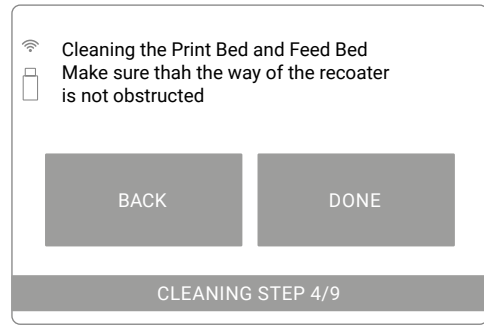

Check the Recoater's path.

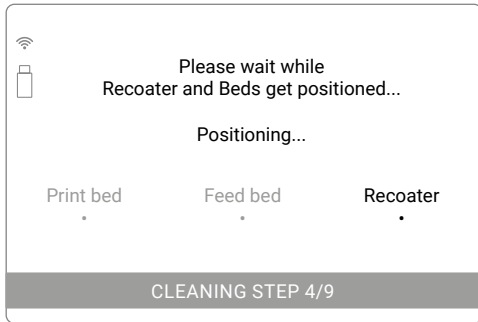

Beds and Recoater's positioning screen.

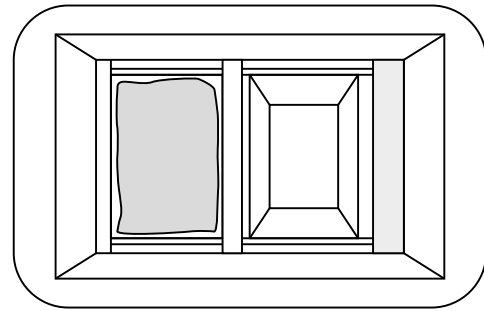

View of the Print Chamber after the positioning of Beds and Recoater.

4. During the positioning process, you can prepare the necessary devices: PHS or ATEX Vacuum Cleaner with Powder Separator.
5. Prepare the devices according to their instructions (We recommend to read the full user manuals available with your Sinterit device or at www.sinterit.com/support-page).

6. Place an Antistatic hose with a suitable nozzle (either ATEX Vacuum Cleaner, Powder Separator or PHS) in the Print chamber and clean all components, especially the Print Bed and Feed Bed.

Keep the nozzle just above the powder surface.

7. After cleaning, continue by pressing the DONE button.

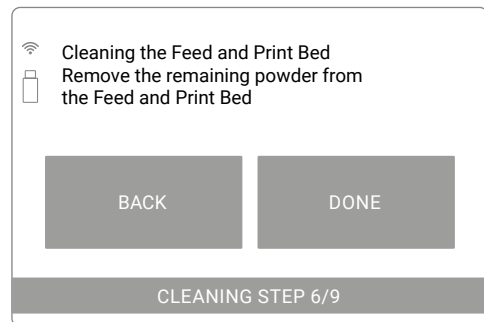

The screen of the cleaning Print chamber.

Cleaning with PHS:

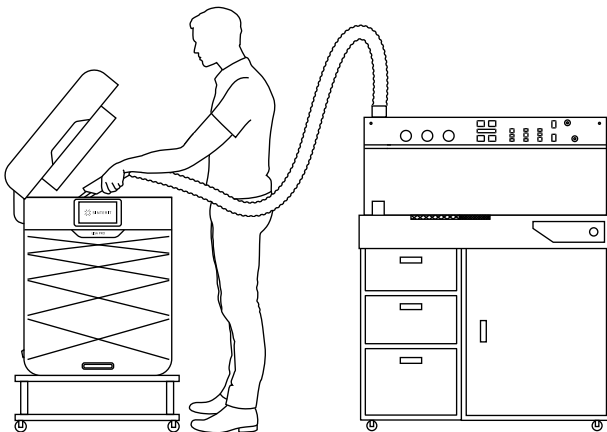

Use the Sinterit PHS and remove all powder from the Print Chamber.

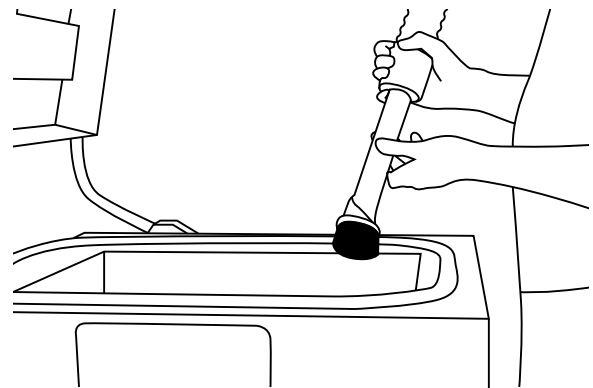

Use the appropriate nozzle for Suction Handle to remove the powder.



Cleaning with Sinterit Cleaning System:

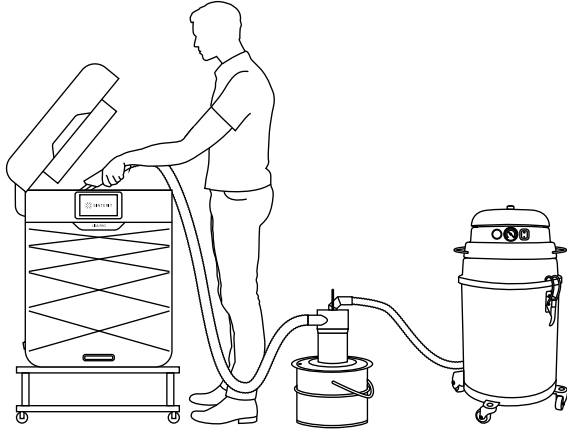

Use the Sinterit Cleaning System and remove all powder from the Print Chamber.

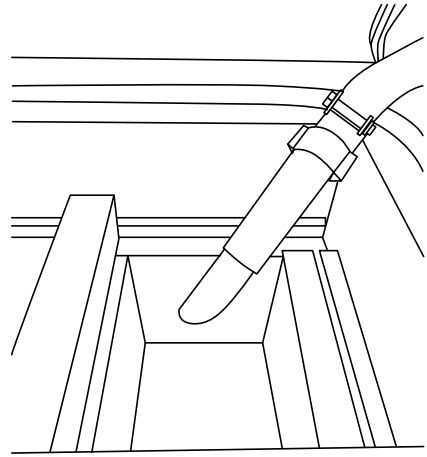

Use the appropriate nozzle for Antistatic hose to remove the powder.

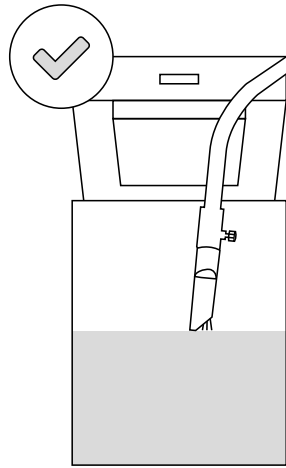
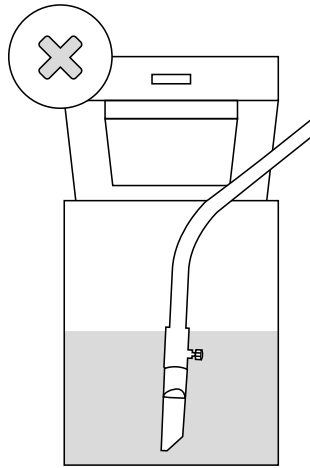

Incorrect and correct removing the powder from the Print Chamber.

8. Clean the space around the Beds and under the Recoater. To move the Recoater use ► (right) or ◀ (left) buttons on the screen.
9. When the cleaning is finished and the DONE button is pressed, a screen will appear with a message about the amount of powder that needs to be added to refresh the powder taken out of the printer. This is a necessary process, especially for polyamides, to print correctly in the next printing cycle.
10. After adding Fresh Powder as shown on the screen and pressing the DONE button, the cleaning process will be completed. The printer will return to the MAIN MENU screen.

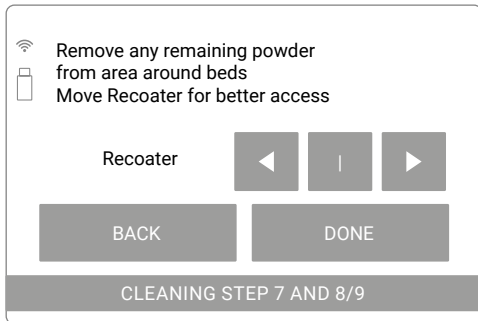

The screen for the Recoater manual moving.

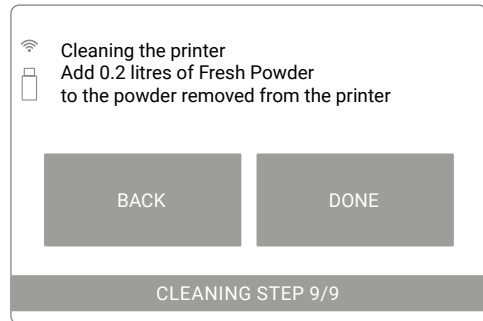

The printer will show you how much to add Fresh Powder to refresh the powder from the printer.



C. CLEANING THE PRINTER IN MANUAL OPTION

Manual cleaning is a longer process in which you will need Dedicated Powder Tools (especially Set of Scrapers and Brush).

You will need:

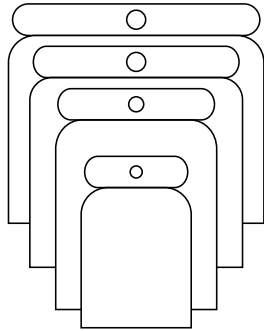

the set of Scrapers

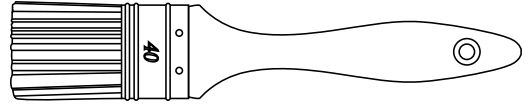

a Brush

1. When you press the MANUAL option on the screen, a dedicated cleaning process will start. This is the dedicated process in case you do not have the Sinterit Cleaning System or PHS. This is a longer process.

Read all messages on the printer screens carefully!

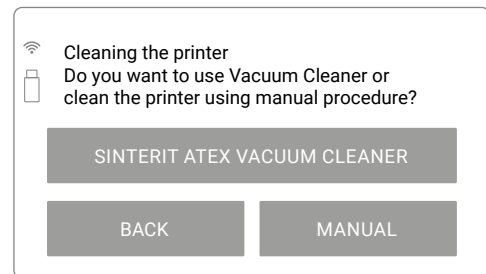

Screen to choose the method of cleaning the printer: manual or with ATEX vacuum cleaner.

2. Press CLEAN FEED BED on the screen.
 - If the Feed Bed is clean you can skip this step by pressing FEED BED ALREADY CLEANED.

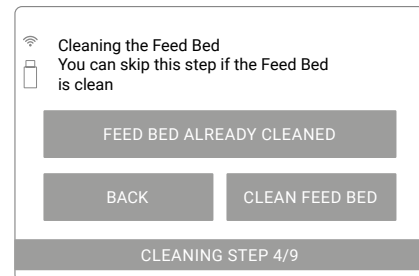

Screen initiating the cleaning process of the Feed Bed.

3. Check that the way of the Recoater is not obstructed and press the DONE button.
4. The positioning of the Recoater and the Beds will start. After this operation, the Print Bed will go down maximum, the Feed Bed will move up and the Recoater should be on the Overflow Bin side.

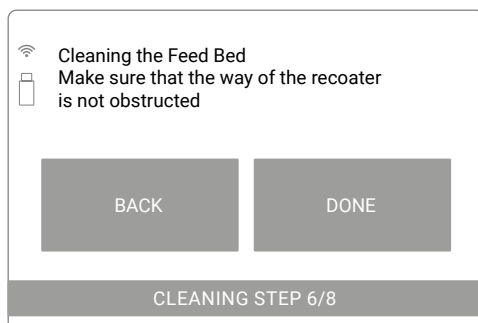

Check the Recoater's path.

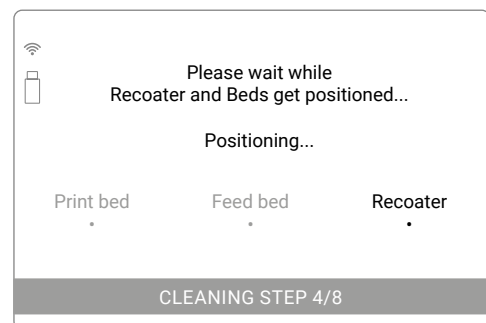

Beds and Recoater's positioning screen.

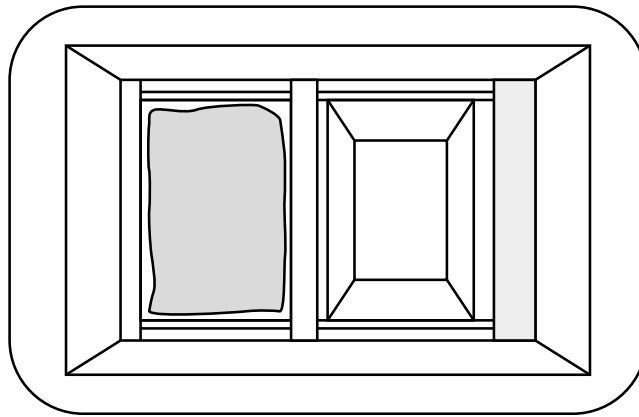

View of the Print Chamber after the positioning of Beds and Recoater - Feed Bed cleaning process.

5. Transfer all powder from Feed Bed to Print Bed.
6. Clean the space around the Beds and press the DONE button. Use a spatula and brush to thoroughly clean the space, especially under the Recoater guide bar.

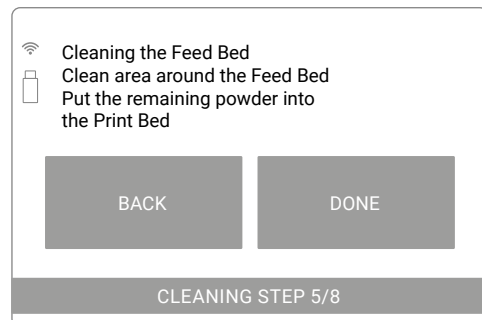

The screen of the cleaning Feed Bed.

7. Press the CLEAN PRINT BED screen to start the Print Bed cleaning process.
 - If it is clean you can skip this step by pressing the PRINT BED ALREADY CLEANED.
8. Check that the way of the Recoater is not obstructed and press the DONE button.
9. The positioning of the Recoater and the Beds will start. The Recoater will go to the Feed Bed side and then the Print Bed will move up to the top.

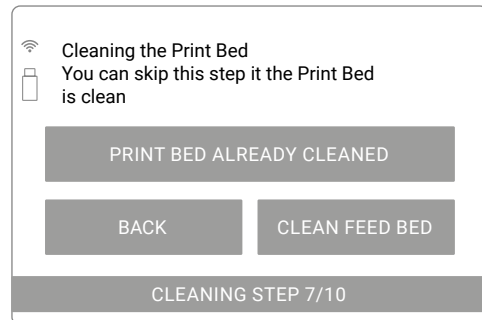

Screen initiating the cleaning process of the Feed Bed.

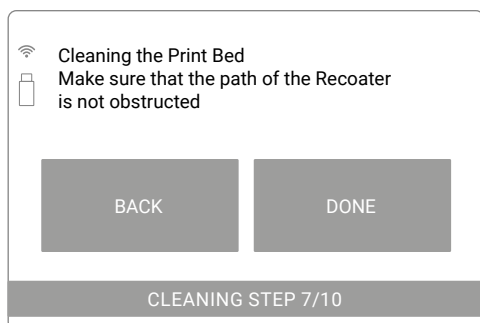

Check the Recoater's path.

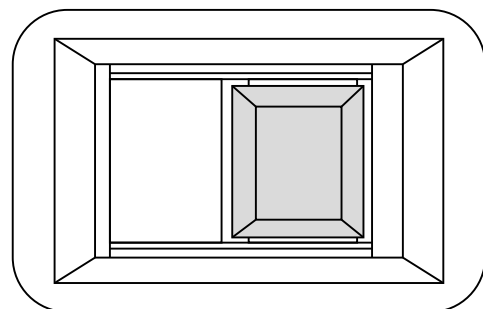

View of the Print Chamber after the positioning of the Beds and Recoater - Print Bed cleaning process.



10. Transfer the powder from the Print Bed to Overflow Bin (through the Overflow Bin gap).
11. Also, put the remaining powder around the Beds to Overflow Bin, then press the DONE button.
 - Use the Spatulas and the Brush to thoroughly clean the space, especially under the Recoater guide bar.

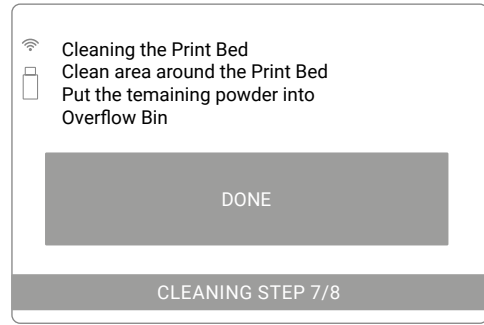

The screen of the cleaning Print Bed.

12. Unlock and clean the Overflow Bin. The magnetic blockade deactivates for 10 seconds. After 10 seconds, it will reactivate.
13. When the cleaning is finished and the DONE button is pressed, a screen will appear with a message about the amount of powder that needs to be added to refresh the powder taken out of the printer. This is a necessary process, especially for polyamides, to print correctly in the next printing cycle
14. After adding Fresh Powder as shown on the screen and pressing the DONE button, the cleaning process will be completed. The printer will return to the MAIN MENU screen.

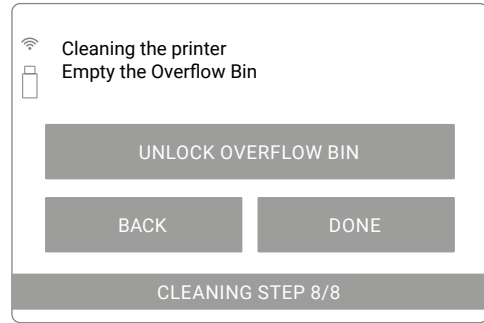

Overflow Bin unlock screen.

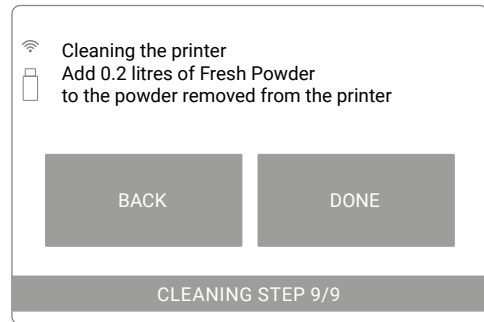

The printer will show you how much to add Fresh Powder to refresh the powder from the printer.



12. Cleaning the prints and postprocessing



ATTENTION!

- Before starting any work with powder, always wear adequate protective clothing, eyewear, face mask, and gloves.
- A suitable set is included in the DEDICATED POWDER TOOLS for Lisa PRO printer as PERSONAL PROTECTION kit.

Sinterit offers dedicated tools and devices to facilitate printout cleaning. Depending on the needs, the user can compose a set tailored to his needs.

For easy cleaning of printouts we recommend:

- a. Devices: PHS with an explosion-proof certificate vacuum cleaner, Sandblaster and Sandblaster XL:

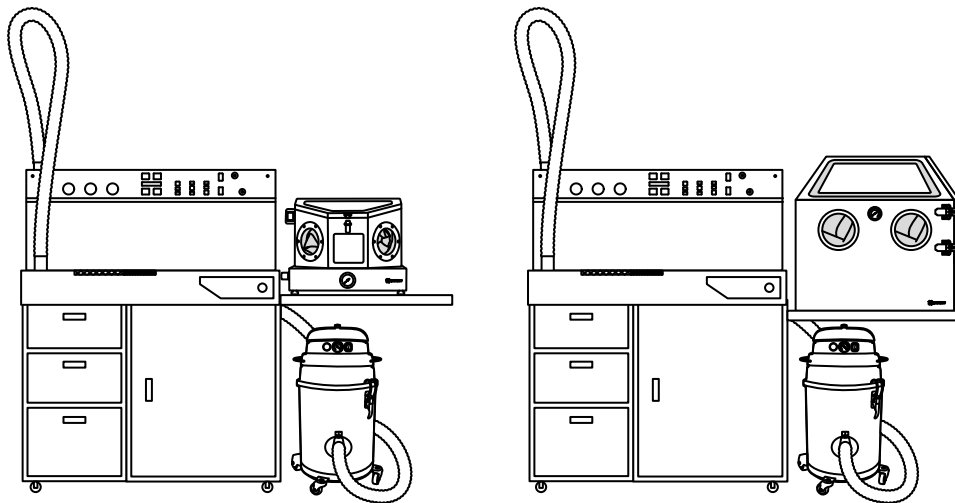

- b. Tools (only the cleaning tools are shown in the picture - they are part of the Dedicated Powder Tools):

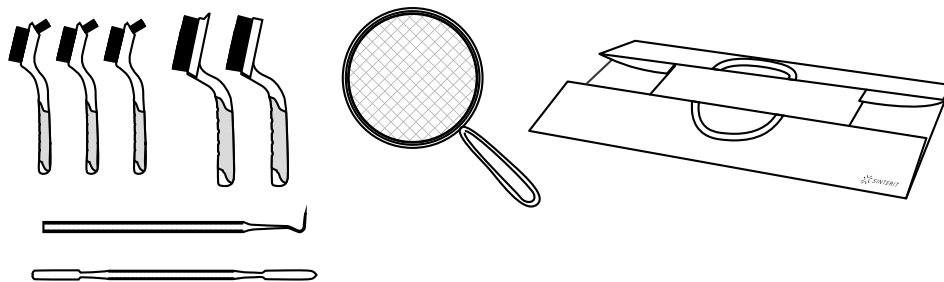

Post Processing Tools (set of Large brushes, set of Small brushes, Metal strainer, Stainless steel probe, Metal spatula) and Foldable Tray

A. CLEANING OF THE PRINTOUTS WITH SINTERIT PHS DEVICE



IMPORTANT!

Cleaning of printouts should be made with a PHS device and vacuum cleaner (a source of pressure). These steps only concern the cleaning of the printouts. For full instructions on cleaning the printer and refreshing the powder with PHS, please read the manual of the PHS device.

1. Gently pour the contents of the Print Bed from the IO Box onto the Powder Chamber grid.
2. Clean the IO Box using a brush and put it back in Drawer 2.

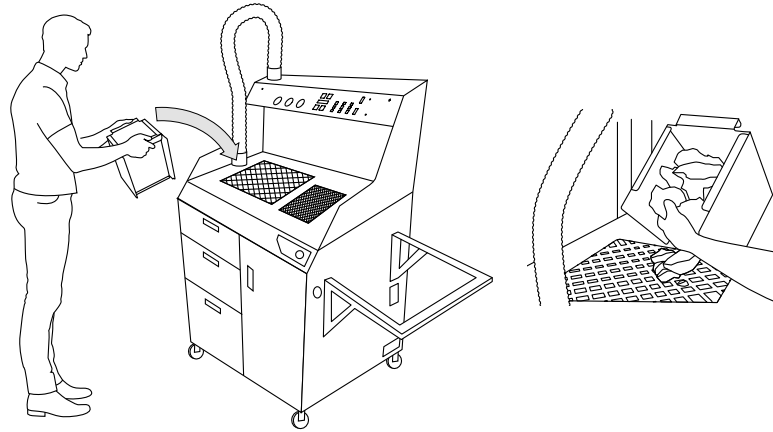

Pour the contents of the IO Box onto the Powder Chamber grid.

- 3. Starting with the external layers of the cake, crush it and push the powder through the grid. Watch out for prints inside the cake body.
- 4. In the end, check the amount of powder in the Powder Chamber. You can lift the grid and, with a Powder Wiper, clean the walls of the chamber from the powder deposited. Do not remove the Powder Feeding Screw guard inside the chamber!

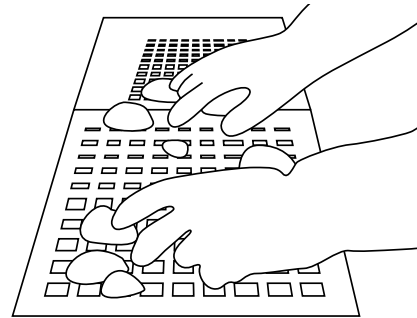

Pour the contents of the IO Box onto the Powder Chamber grid.

- 5. The overflow of powder (or when the powder is solidified and does not sieve) and collected on the Powder Feeding Screw guard can be pressed into the chamber with the Trowel. Only the powder below the guard will be transported and sucked in.
- 6. Remember to put the grid back on the Powder Chamber.

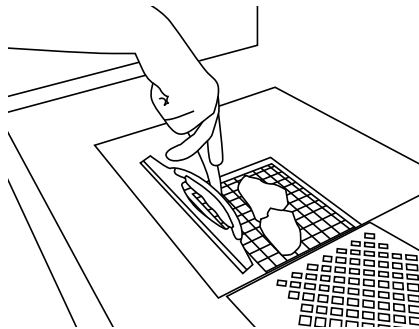

Clean the Powder Chamber walls from embedded powder.

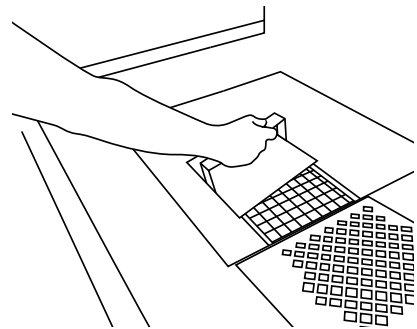

Use the Trowel to push the powder through the Powder Feeding Screw guard.

- 7. The extracted prints should be cleaned above the Fine Dust Chamber grid with brushes, stainless steel probes, and spatulas, and placed on the Worktop (or on the Foldable Tray on the right - if there is no sandblaster placed there).
- 8. Powder located in Overflow Bin from the printer should be poured on the Powder Chamber grid.

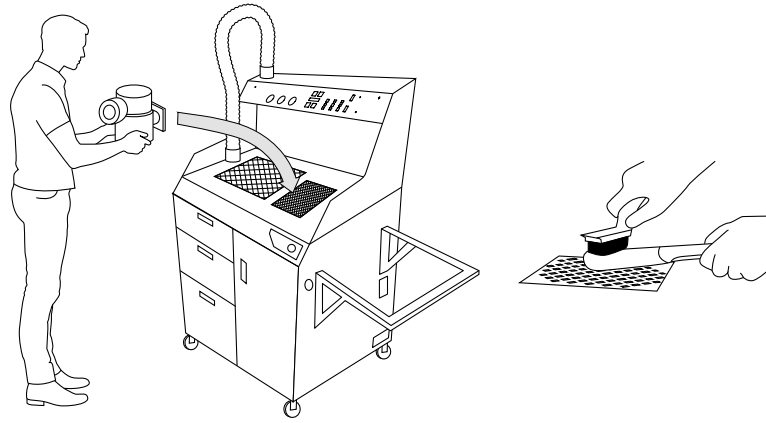

Place the printout over the Fine Dust Chamber grid and clean thoroughly.



ATTENTION!

Do not pour the powder from Overflow Bin into the Fine Dusting Powder Chamber! When the machine is in operation, this chamber must always have access to air for the entire system to function properly. It is allowed to clean the prints above it.

- 9. Place the pre-cleaned printouts in the sandblaster (if you have one) and clean thoroughly with compressed air.
- 10. After this operation, the printout is cleaned and ready to use.

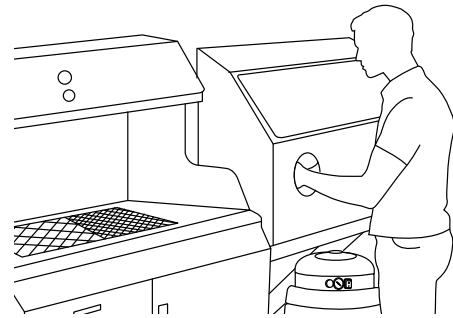

The sandblaster allows for quick and thorough cleaning of printouts from the powder remains.

B. CLEANING OF THE PRINTOUTS WITH DEDICATED TOOLS

- 1. Gently pour the contents of the Print Bed from the IO Box onto the Foldable Tray.
- 2. Clean the IO Box using a brush and put it back on the place.

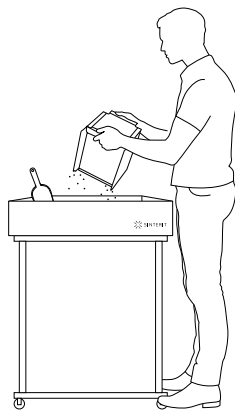

Transfer the contents of the Print Bed to the Foldable Tray.

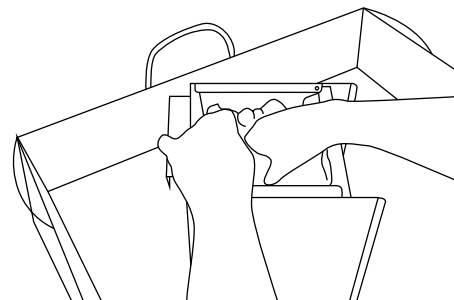

If the cake with the printout is cooled, you can pre-crush it in the IO BOX.



- Starting with the external layers of the cake block, crush it with your hands or using large metal brushes.
 - Be careful with the printouts inside the cake block.
 - If the cake block inside is still hot/warm, leave it to cool.
- Gently separate the printouts from the rest of the unsintered powder. Set the printouts aside.
- Crush the remaining powder with your hands into as small pieces as possible to check that all the parts have been removed from the cake.

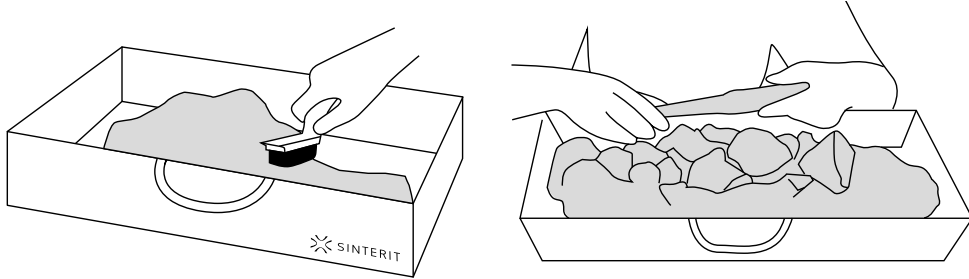

Gently remove printouts from the cake block.

- Clean the printouts with the set of brushes and metal probes.
- To clean your printouts even more precisely and quickly, we recommend using the sandblaster (we recommend the Sinterit Sandblaster or Sinterit Sandblaster XL).

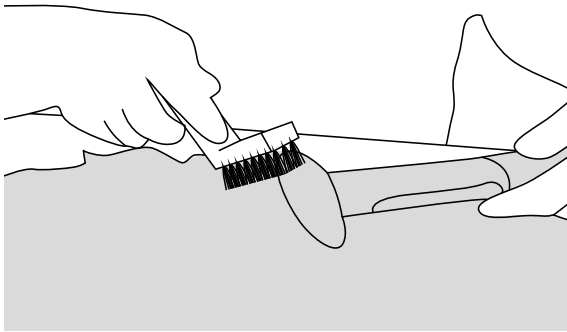

**Manually clean the printouts of excess powder.
Use appropriate tools.**

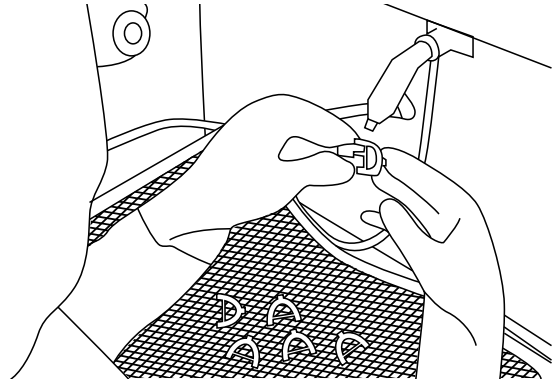

We recommend sandblasting the printouts.

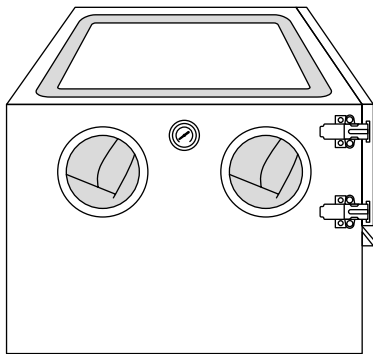

Sinterit Sandblaster XL.

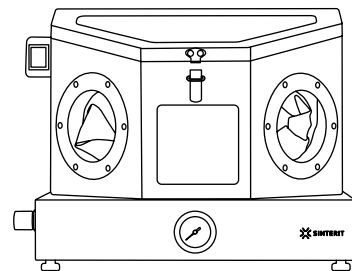

Sinterit Sandblaster.

- The remaining powder in the Foldable Tray should be sifted through a sieve (we recommend Sinterit Powder Sieve or Metal Sieve) and mixed with that left in the printer and Fresh Powder if required. For the full powder refreshing process, please refer to chapter 13.

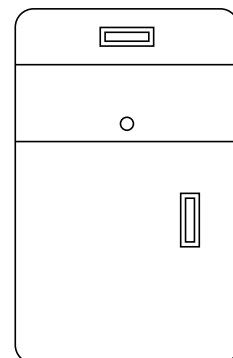

Sinterit Powder Sieve.

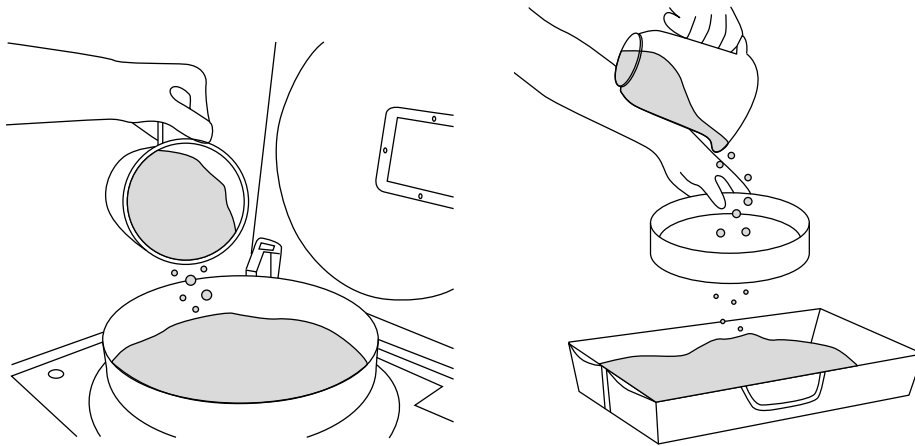

Two ways of manually sifting the powder (Sinterit Powder Sieve or Metal sieve).

9. Printouts are cleaned and ready to use. They may also undergo further processing (e.g. polishing, sealing, painting).

C. POSTPROCESSING: PAINTING AND LACQUERING

SLS parts can be spray painted and/or coated with lacquer (varnish or clear coat). Via lacquering it is possible to obtain various finishes, such as high gloss or metallic sheen. Lacquer coatings can also improve wear resistance, surface hardness, water-tightness and limit marks and smudges on the surface of the part. Due to the porous nature of SLS, it is recommended that 4- 5 very thin coats are applied to achieve a final finish rather than one thick coat. This results in faster drying time and reduces the likelihood of the paint or lacquer running.

13. Powder refreshment process

1. This chapter will explain the process of refreshing powders that need it.
2. Full information about refresh ratio and recommendations can be found in specifications of each material that can be found at www.sinterit.com
3. Some powders (i.e. Flexa Grey) do not need to be mixed with fresh powder. It is sufficient to sift them after use in the printer (e.g. using Sinterit Powder Sieve or Sinterit PHS). After this process, the powder is ready for the next use.

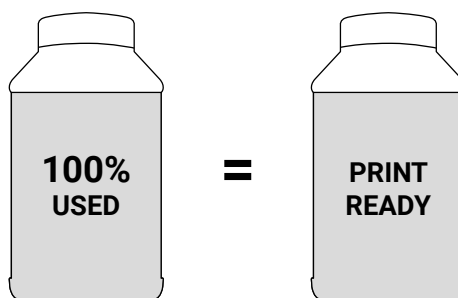

For FLEXA Grey powders, there is no need to add fresh powder.

4. Powders need to be sifted (powder from the printer), a fresh powder added (appropriate amount - see further) and mixed (homogenisation).
5. The exact amount of Fresh Powder that should be added to that used powder (from the printer) can be found in the Sinterit Studio report (generated together with the xxx.scode file) and on the printer screen, during the cleaning process (see chapter 11, subchapter B or C).



ATTENTION!

- Before starting any work with powder, always wear adequate protective clothing, eyewear, face mask, and gloves.
- A suitable set is included in the DEDICATED POWDER TOOLS for Lisa PRO printer as PERSONAL PROTECTION kit.

A. REFRESHING THE POWDER USING THE PHS DEVICE

NEW PRINTING POWDER = ADDING FRESH POWDER TO THE USED ONE + MIXING

STEP ONE - ADDING FRESH POWDER TO THE USED POWDER FROM PRINTER

1. Prepare a portion of Fresh Powder according to the information provided on the printer screen or in the Sinterit Studio report.
2. When the sifting process is finished, remove the Metal container from the PHS device with the used, sifted powder (remember to insert a new, empty container).
3. Add Fresh Powder to the Used Powder in the Metal container. Close tightly using the lid and clamping ring.
4. Shake the container for at minimum 15 seconds so that both powders are pre-mixed. We will have a Pre-Print Ready Powder, which should be mixed in the PHS.
5. Before opening the container, wait a while for the powder to settle.

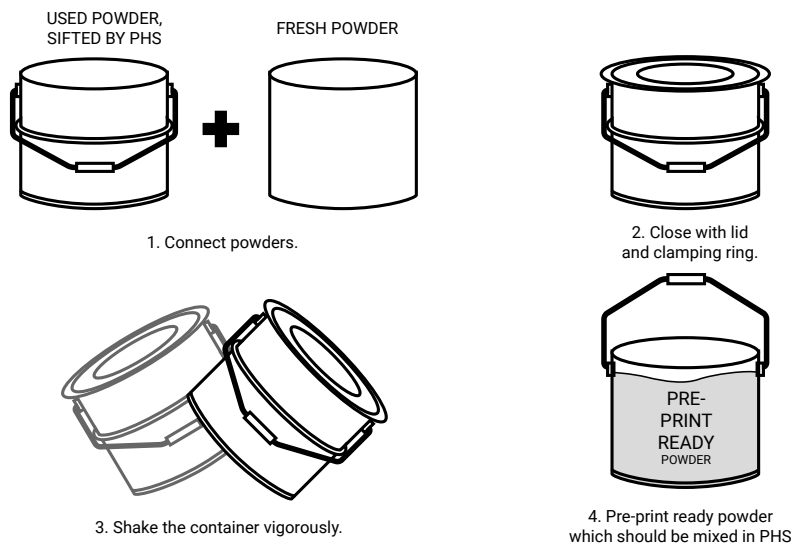

Connecting the powders.

STEP TWO - MIXING OF POWDER (HOMOGENISATION)

To ensure that both types of powders mix thoroughly (both in the first and second method), we recommend sieving them 2-3 times to obtain a homogeneous blend.

1. Take out from Drawer 3 and place the Funnel on the Metal container. Remember to put a clamping ring between the Funnel and the Metal Container.
2. Turn on the vacuum cleaner (from „0” to „1”). Vacuum Suction sensor indicator should light up.
3. Press the ON/OFF Sifting button to turn on the Sifting Module and the Powder Feeding Screw.
4. On the Control panel, in the SUCTION section, the LED above the DEPOWDERING ZONE should be activated.
5. Gently pour the entire content of the Metal container onto the Powder Chamber grid. Remember not to pour the powder on the grid of the Fine Dust Chamber - there must be access to the air!
6. After emptying the Powder Chamber and sifting the powder, remove the Metal container from the Sifting module and put a new one in its place.
7. To ensure homogeneous mixing of the powders, repeat steps 1-6 at least once more.
8. The newly created powder (Print Ready Powder) is mixed and ready to use in the Sinterit Lisa/Lisa PRO printer.

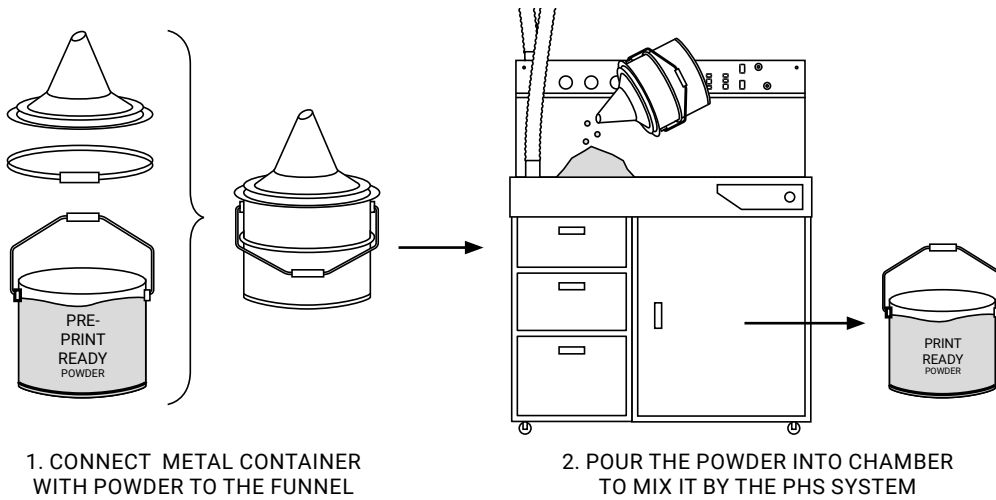

Process of mixing of both powders (Pre-Print Ready) - powder homogenization.

B. REFRESHING THE POWDER USING THE POWDER SIEVE OR METAL SIEVE

STEP ONE - ADDING FRESH POWDER TO THE USED POWDER FROM PRINTER

1. Prepare a portion of Fresh Powder according to the information provided on the printer screen or in the Sinterit Studio report.
2. Sift all the powder from the printer, used during the last printing. Use Sinterit Powder Sieve or Metal Sieve.
3. Add Fresh Powder to the sifted Used Powder in the Metal container. Close tightly using the lid and clamping ring.
4. Shake the container for minimum 15 seconds so that both powders are pre-mixed. We will have a Pre-Print Ready Powder, which should be mixed in Sinterit Powder Sieve.
5. Before opening the container, wait a while for the powder to fall.

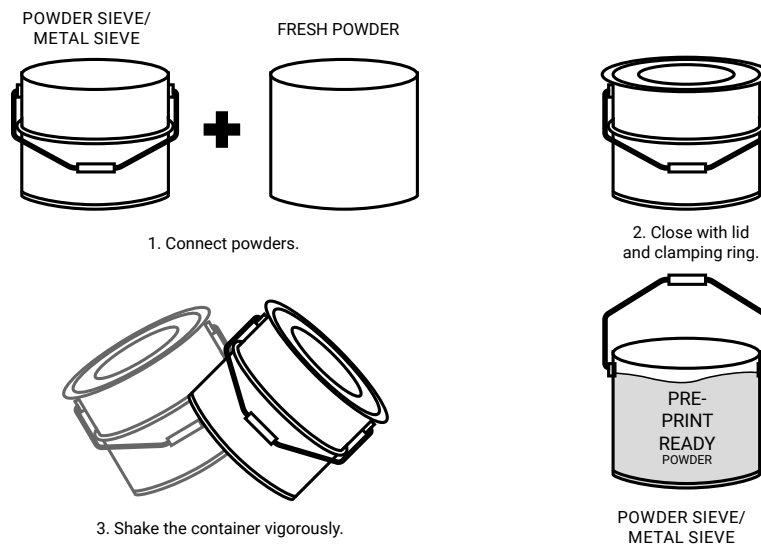

Connecting the powders.



STEP TWO - MIXING OF POWDER (HOMOGENISATION)

To ensure that both types of powders mix thoroughly, we recommend sieving them 2-3 times to obtain a homogeneous blend.

1. If you have one, put the Funnel on the Metal container. Remember to put a clamping ring between the Funnel and the Metal Container.
2. Gently pour the entire contents of the Metal container onto the Removeable Metal Sieve (in Powder Sieve) or sift it manually using the Metal Sieve.
3. Close the Powder Sieve lid and switch on the device.
4. Wait until all the powder has been sifted.
5. Disconnect and remove the Metal container from inside the Powder Sieve and put a new one in its place.
6. Shake the closed container with the powder for at least 15 seconds.
7. To ensure homogeneous mixing of the powders, repeat steps 1-5 at least once more.
8. The newly created powder (Print Ready Powder) is mixed and ready to use in the Sinterit Lisa PRO printer.

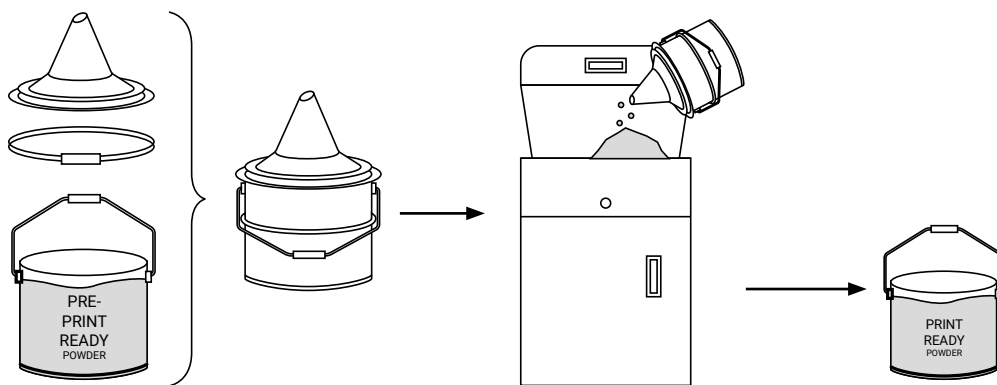

1. CONNECT METAL CONTAINER WITH POWDER TO THE FUNNEL

2. SIFT THE PRE-PRINT POWDER IN A POWDER SIEVE / METAL SIEVE

Process of mixing of both powders (pre-Print Ready) - powder homogenization.

14. Printing - advanced mode

	<p>ATTENTION!</p> <ul style="list-style-type: none">• Before starting any work with powder, always wear adequate protective clothing, eyewear, face mask, and gloves.• A suitable set is included in the DEDICATED POWDER TOOLS for Lisa PRO printer as PERSONAL PROTECTION kit.
	<p>CAUTION!</p> <ul style="list-style-type: none">• Beware of sharp edges, especially on the Lid.
	<p>IMPORTANT!</p> <ul style="list-style-type: none">• For the first use of the Sinterit Lisa PRO printer with PA12 Smooth or PA11 Onyx, please use only the powder from the container labelled STARTER POWDER.• The process of mixing powders will be described in a separate chapter.• This option assumes that you know how to prepare the printer for printing without prompts.



If you are already familiar with printing in Simple Mode and want to adjust the printer parameters yourself in order to better suit your needs, then you can print using Advanced Mode.

1. To enter advanced mode press the CONTROL PANEL button on the main menu. Next choose MORE OPTIONS and then ADVANCED MODE.

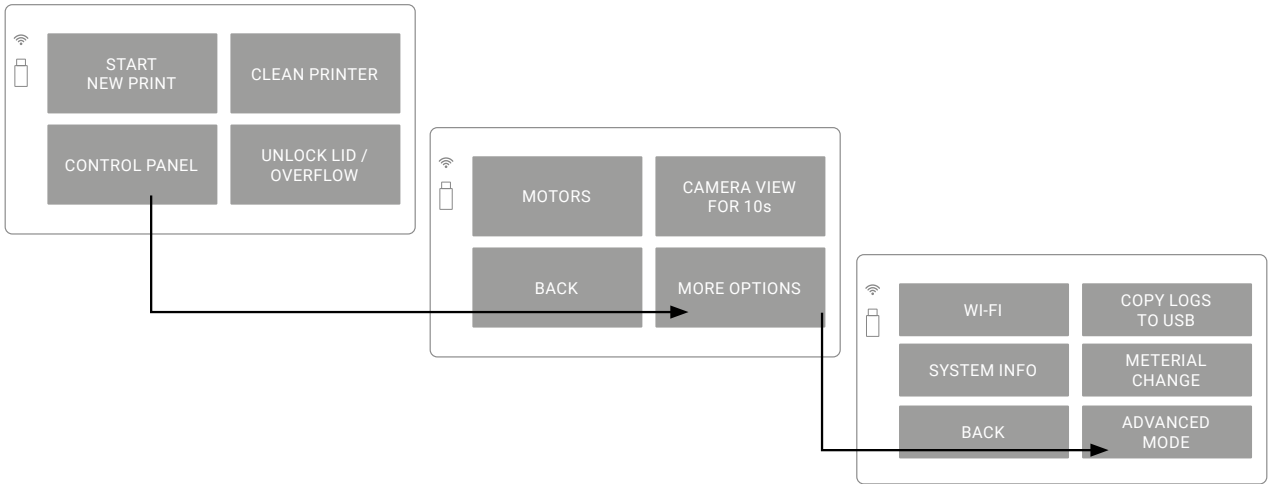

The ADVANCED MODE panel opening path.

2. After pressing the ADVANCED MODE button you will see a warning. If you want to start each printing session with customized changes, check the ALWAYS START IN ADVANCED MODE box and press SWITCH TO ADVANCED MODE.

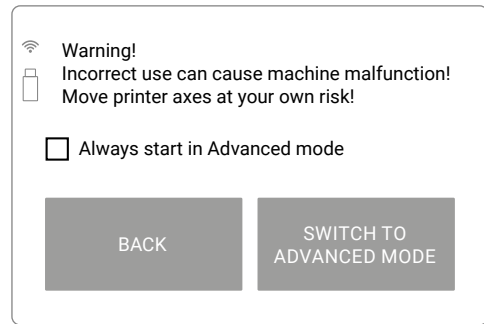

Warning displayed before switching to ADVANCED MODE.

	<p>ATTENTION! Change parameters carefully. Careless changes may result in the printer malfunctioning. You make adjustments at your own risk!</p>
	<p>IMPORTANT! You can return to Simple Mode at any stage.</p>

3. PRINT - this tab allows you to:
 - LOAD MODEL - select the file for printing. You can choose 3 options:
 - RECENT MODELS - if the file is in the internal memory of the printer,
 - LOAD FROM USB - if the file is saved on the USB Flash Drive,
 - UPLOADED MODELS - if the file was sent via Wi-Fi.



☼	Print	Mechanics	Temp.	Advanced
☼	Load Model		Unlock Lid/Overflow	
	▶ Start			
	Waiting to start			

The PRINT panel.

☼	◀			
☼			Uploaded Models	
	Recent Models			
			Load from USB	

The LOAD MODEL panel.

After uploading the file, you will be able to automatically position the Feed Bed. You can skip this option if you want to adjust it's level yourself.

- UNLOCK LID / OVERFLOW - this button releases the electrolock of the printer Lid and/or Overflow Bin for 10 seconds. Only after pressing this button is it possible to open the printer lid or remove the Overflow Bin,
 - START - this button will start the printing process. It will be available to choose when the file is loaded.
4. Mechanics - this tab allows you to change the height of feed bed, print bed and position of recoater.

- RECOATER - press ◀ to move the recoater all the way to the left or press ▶ to move the recoater all the way to the right,

☼	Print	Mechanics	Temp.	Advanced
☼	Recoater		▶	◀
	▲ Feed		▲ Print	
	▼ Feed		▼ Print	
	Start Leveling			

The MECHANICS panel.



IMPORTANT!

Before you can move the Recoater freely, you have to press ▶ which will allow homing of the recoater.

- FEED - press ▲ to raise the Feed Bed by one step or press ▼ to lower the Feed Bed by one step,
- PRINT - press ▲ to raise the Print Bed by one step or press ▼ to lower the Print Bed by one step,
- START LEVELING - press this button to start the process of leveling the powder surface with the recoater.



- 5. TEMPERATURE - this tab allows you to change the temperature of the print surface. Press + to increase the temperature or - to decrease it.

	Print	Mechanics	Temp.	Advanced
	Print surface 36.6°C		+	-

The TEMPERATURE panel.

After changing the temperature, the difference between the default temperature and the modified temperature will be displayed on the screen.

Allowed range of change: from -5.0 [°C] to +5.0 [°C]

	Print	Mechanics	Temp.	Advanced
	Print surface 36.6°C User offset: +0.5°C		+	-

Showing the temperature offset.

- 6. Advanced - this tab you can find:
 - SELECT WI-FI - Status of the printer's connection to the Wi-Fi network. The name of the currently chosen network is displayed, to the right of the "Select Wi-Fi" option.
 - SIMPLE MODE - allows you to switch from advanced mode to simple mode.
 - COPY LOGS TO USB - allows you to copy the logs from the printer to the USB flash drive (and e.g. send to the Sinterit Support, in case of problems)
 - ABOUT - displays the printer's basic information, such as: model name, version and serial number

	Print	Mechanics	Temp.	Advanced
100%	Select Wi-fi		fubar (CONNECTED)	
90%				
80%				
70%				
60%	Simple Mode		Copy logs to USB	
50%				
40%				
30%	About			
20%				
10%				

The ADVANCED panel.

- 7. After pressing the SIMPLE MODE button in the ADVANCED panel, a window will appear with information about the possibility of starting each subsequent printing with Advanced Mode.
 - If you want to use Advanced Mode once, uncheck the box and press the SWITCH TO SIMPLE MODE button.
 - If you want to use Advanced Mode by default, check the box and press the SWITCH TO SIMPLE MODE button

	<input checked="" type="checkbox"/> Always start in advanced mode		
	Back	Switch to Simple Mode	

Choosing between Simple Mode and Advanced Mode.



15. Working with the powders

A full list of restrictions, warnings and handling of powders can be found in chapter 3 „Important safeguards and warnings“, subchapter G „WORKING WITH POWDERS“.

	<p>ATTENTION!</p> <ul style="list-style-type: none"> When working with the polyamide powder or other designated printer powder for the Sinterit Lisa PRO printer, always wear Personal Protection dedicated to this device (Protective Glasses, Protective Gloves, Protective Dust Mask). When working with a powder material, avoid inhalation or swallowing and contact with skin and eyes. 		
--	--	--	--

A. MATERIALS USE WITH NITROGEN

Some materials in our offer require using the Nitrogen Installation during the printing process i.e. PA11 ONYX and PA11 ESD. Its full characteristics are available at www.sinterit.com.

The Nitrogen Installation can be also used with 3rd party materials if you own Sinterit STUDIO version with open parameters feature (Sinterit STUDIO OPEN or Sinterit STUDIO ADVANCED).

B. RULES AND PROCEDURE FOR CHANGING THE POWDER IN THE PRINTER

The thorough cleaning procedure must be performed if you switch from any material with a lower melting point to a material that melts at a higher temperature.

Powder type	PA12 Smooth	PA11 Onyx	PA11 ESD	Flexa Grey	Flexa Soft	Flexa Bright	TPE
Melting point	179-185°C	198-206°C	198-206°C	160°C	150°C	160°C	190°C

When you change:

I. Material with a higher melting point (H) to material with a lower melting point (L):

- When changing from H to L, no dutiful cleaning of the inside of the printer is required. The same actions as cleaning the machine after printing should be carried out.
- We recommend cleaning the Print Chamber with Sinterit ATEX Vacuum Cleaner.

II. Material with a lower melting point (L) to the material with a higher melting point (H):

- When changing L to H it is required to clean the machine very precisely. Special attention should be paid on the bottom and side walls of the print and Feed Bed as well as the Recoater guide bar. It is also recommended to clean the area around the BEDs using compressed air or Sinterit ATEX Vacuum Cleaner. It's also necessary to disassemble the Recoater cover and remove the remaining powder.
- It is important to clean the printer as thoroughly as possible before adding H; otherwise, the remaining L (e.g. FLEXA with its properties similar to rubber, becoming liquid in temperatures above 100°C) may get into the mechanism responsible for moving the BEDs or the Recoater mechanism, and damage the machine.
- Clean the Laser Protective Glass as some fumes may release during printing with FLEXA and make the glass foggy. If it is hard to clean the surface, you can use ethyl acetate.

C. CLEANING THE MACHINE WHEN CHANGING POWDER

To make it easier for the user to change the powder in the printer, a dedicated process has been created which makes it easier and leads step by step thru cleaning the printer.

To make the process even faster and more accurate, we recommend using the Sinterit ATEX Vacuum Cleaner with a PVC brush or optional compressed air (care must be taken to ensure that the powder does not rise into the air).

**ATTENTION!**

- Wear individual protections.
- Protect your face and hands.

1. To start it press: CONTROL PANEL//MORE OPTIONS// MATERIAL CHANGE.
2. A message will appear: „HAVE YOU CLEANED THE PRINTER AFTER LAST USE?“
 - If the powder is in the printer and you press „NO, THE POWDER IS STILL INSIDE“ button the printer will go to "CLEAN PRINTER" and guide you through the process of cleaning the machine.
 - If there is no powder in the printer, press the „YES“ to go further.

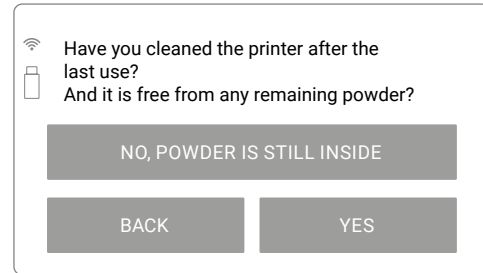
**Check that you have cleaned the printer before.**

3. The procedure is needed when you change the powder from a lower melting point to a higher one.

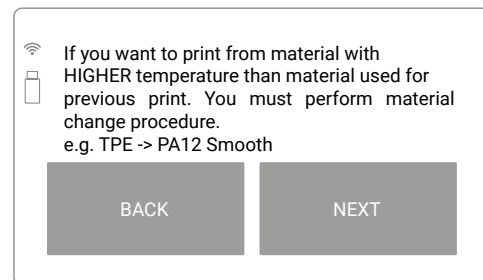
**The procedure necessary when changing the powder from a lower to a higher melting point.**

4. After pressing the NEXT button, the BEDs and Recoater homing process will start. Make sure that the way of the Recoater is not obstructed and click the DONE button.

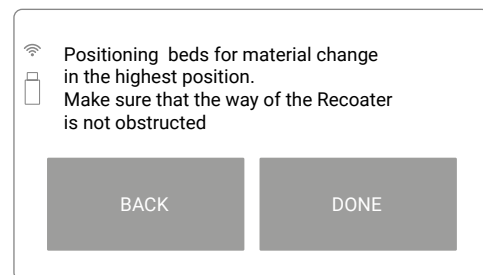
**Check that the Recoater path is not obstructed.**

5. Homing will end when BEDs are in the highest position and Recoater is between the BEDs.

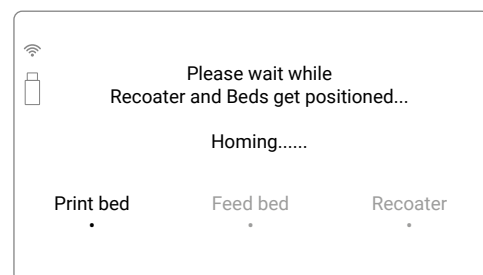
**Beds and Recoater's positioning screen.**

6. Clean the Print Chamber and all the components inside thoroughly. We suggest using Sinterit ATEX Vacuum Cleaner with a PVC brush or compressed air (be careful that the powder does not rise into the air).

After cleaning everything, press the DONE button.

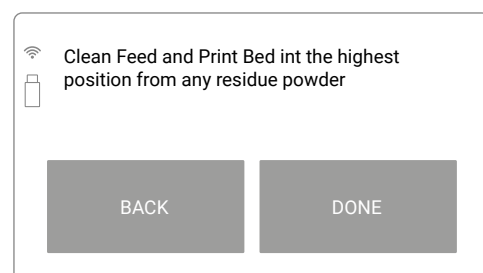
**Clean the Print Chamber from all remaining powder.**



7. After cleaning the Print Chamber in the highest position, it is necessary to repeat the operation in the lowest position of the BEDs (the whole height of the BEDs must be cleaned of powder).

When pressing the DONE button, the positioning of the BEDs and Recoater to the correct position starts.

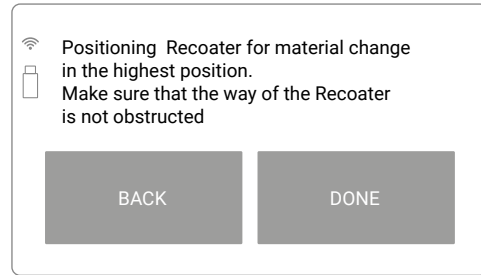

Re-check the Recoater path before lowering the Beds.

8. The process is divided into two steps. In the first one, the Recoater is set up over Feed Bed. This allows it to be cleaned from underneath without having to remove the cover. Pay special attention to the Recoater rotary shaft and bearing system.

We recommend using Sinterit ATEX Vacuum Cleaner or compressed air.

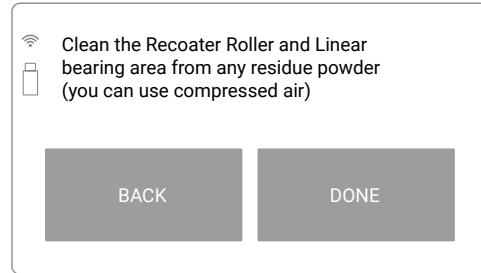

Clean all elements of the Recoater.

9. After cleaning the Recoater and pressing the DONE button, the positioning of the Recoater will start and the second cleaning step will start in the lowest position.

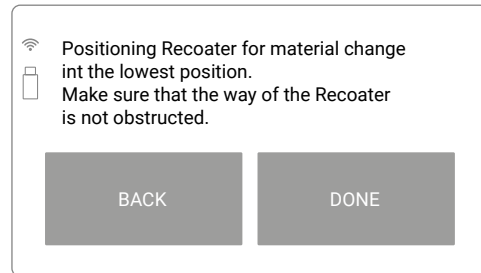

Clean the Print Chamber thoroughly after lowering the Beds.

10. Once the Recoater is positioned between the BEDs, you can thoroughly clean the walls of the BEDs and the entire Print Chamber. We suggest using Sinterit ATEX Vacuum Cleaner with a PVC brush or compressed air (be careful that the powder does not rise into the air).

11. After all the steps are completed, press the DONE button. Your machine is clean and ready to print with new powder.

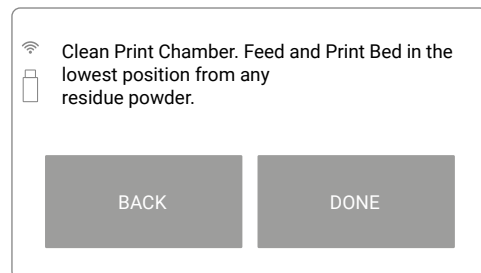



When all steps are done, the printer is ready for the new powder.



16. Maintenance and daily service of the Sinterit Lisa PRO Printer

This section describes the control and special maintenance operations crucial for keeping the printer in perfect working condition.

	<p>ATTENTION! Maintenance jobs must always be performed by skilled technicians, trained to carry out their specific jobs.</p>
	<p>ATTENTION! Before doing any maintenance job you must:</p> <ul style="list-style-type: none">• Make sure that you have carefully read the instructions contained in this manual and know how the printer works.• Make sure there are no unauthorised people in the work area.• Make sure the necessary tools are on hand and that these are in good condition.• Make sure that lighting is adequate and, if necessary, provide 24 V portable lamps. <p>Always use tools that are in perfect condition and specifically made for the operation to be done. The use of unsuitable tools or tools not in good condition could cause serious damage.</p>
	<p>ATTENTION! Before starting any maintenance or cleaning job, always wear adequate protective clothing, eyewear, face mask, and/or gloves according to the type of job to be done.</p>

A. DAILY SERVICE WORK WHILE PRINTING

It is recommended to perform the following service work each time you print:

- cleaning the Laser Protective Glass;
- cleaning of the Print Bed pyrometer window;
- cleaning the Recoater guide bar;
- cleaning the inside of the printer lid (around the Reflector) and print chamber above the Overflow Bin gap;
- lubrication of the Recoater guide bar with silicone oil;
- checking the status of the Recoater cord.

For cleaning the above-mentioned parts, use an Alcohol pad or cotton cloth soaked with 2% salicylic spirit (ethanol solution) or any other ethanol-based solution. Do not use isopropyl alcohol!

The printer has built-in screens in the software to remind you of the operation process, placed in the right place on the operating path.

B. LASER PROTECTIVE GLASS - CLEANING AND REPLACING

You will need Protective Gloves, Alcohol pads, Cotton cloth, new Laser Protective Glass (when you must replace it).

	<p>CAUTION! Beware of sharp edges. Put on Protection Gloves to protect yourself from injuring hands against the edge of the Heating module. The Protection Gloves are included in the plastic bag ("Personal Protection" kit) with the Dedicated Powder Tools.</p>
---	---

**STOP!**

- Watch out for the elements of the Heating Module of the device.
- Do not clean the Laser Protective Glass under running water!
- The cleaning process should be carried out outside of the machine.

1. Turn on the printer and wait until the main menu is loaded.
2. Unlock the printer's Lid: press UNLOCK LID//OVERFLOW BIN button on the screen. Remember, you only have 10 seconds to open it before the lock activates again. Softly press and then open the Lid.
3. We recommend turning off the power of the device for cleaning/replacing the Laser Protective Glass. (turn off the Ignition key).
4. While holding the Heating module, take out the Split pin positioned on the top of the inner part of the Lid.
5. Lower the Heating module to get access to the Laser Protective Glass.
- 6.

Cleaning	Replacing
a. Holding the Laser Protective Glass module, unscrew two Quick release nuts on top of the Lid.	a. Holding the Laser Protective Glass module, unscrew two Quick release nuts on top of the Lid.
b. Remove the module from the locking holders located in the middle of the Lid.	b. Remove the module from the locking holders located in the middle of the Lid.
	c. Remove the new Laser Protective Glass module from the box.

7. Put the Laser Protective Glass (or new Laser Protective Glass) on a stable and clean surface.
8. Rub the surface of the glass carefully with an Alcohol pad or cotton cloth soaked with 2% salicylic spirit (ethanol solution) or any other ethanol-based solution. Do not use isopropyl alcohol! Pay attention to any fibres left on the surface. Clean both sides.
9. We also recommended cleaning the metal frame of the module.
10. Remember to wipe the Laser Protective Glass with a dry piece of cloth afterwards.
11. Mount the Laser Protective Glass. Slide the metal tabs of the Laser Protective Glass module into the holders located in the middle of the Lid. Press the gasket gently.
12. After obtaining the perfect fit, screw the two Quick release nuts on to the visible screws.
13. Clean the Laser Protective Glass one more time from any finger marks or stains if present.
14. Join and close the Heating module with the Lid using the metal Split pin.
15. Now turn on the printer one more time.

C. SERVICE AREA UNDER BEDS - CLEANING

You will need Protective Gloves, Protective Dust Mask, Protective Glasses, Sinterit ATEX Vacuum Cleaner or brush.

**WARNING!**

Before cleaning, turn the printer off and unplug the Power cable.

**CAUTION!**

- Beware of moving parts which can crush hands.
- Carefully clean the BEDs stepper motors and their leadscrews.
- Pay attention to the indications inside!

1. Turn off the printer and unplug the Power cable.
2. Put on face and hand protection.
3. Lift the Removeable Front Panel gently.
4. When gripping the Removeable Front Panel from underneath, unfastening each of four Magnetic fasteners one after another. Look out! It's heavy!
5. After removing, put the Removeable Front Panel on a flat, safe surface.
6. Gently remove the powder from the Service area under BEDs using a brush or Sinterit ATEX Vacuum Cleaner, minding the Beds stepper motors.
7. Install the panel. Holding the Removable Front Panel parallel to the printer, mount it using the four Magnetic fasteners at the front. Begin with the upper Magnetic fasteners and then mount the lower ones.
8. After installing the Removeable Front Panel, check that each of the four Magnetic fasteners is connected (pull gently towards you).
9. Now turn on the printer.



D. SHORT INFRARED HEATERS - CLEANING AND REPLACING

You will need: Protective Gloves, Cotton cloth or paper towel, set of the new Short Infrared heaters.



WARNING!

Replace Short Infrared heaters with power disconnected.

1. Turn on the printer and wait until the main menu is loaded.
2. Unlock the printer's Lid: press UNLOCK LID//OVERFLOW BIN button on the screen. Remember, you only have 10 seconds to open it before the lock activates again. Softly press and then open the Lid.
3. Turn off the printer for replacing the Short Infrared heaters.
4. Put on the Protective Gloves.
5. Use a clean cloth or paper towel while replacing the Short Infrared heaters. Do not touch the heaters with your hands!
6. Make sure the Short Infrared heaters are not hot. Carry the operation out when the machine is cold and switched off.
7. Gently grab the Short Infrared heater with your fingers and remove it parallel to its slots. Do not twist it in any direction, it may cause damage to the heater's slots!
8. Insert the new Short Infrared heater to the slot.



IMPORTANT!

If you touch the short Infrared heater by hand, remove it, clean it and install one more time, using gloves or a clean cloth.s.

E. RECOATER CORD - REPLACING

You will need: Protective Gloves, 2mm HEX screwdriver, new Recoater cord



CAUTION!

Beware of moving parts which can snag and pull.



WARNING!

Replace Recoater cord with power disconnected.

1. Turn on the printer and wait until the main menu is loaded.
2. Unlock the printer's Lid: press UNLOCK LID//OVERFLOW BIN button on the screen. Remember, you only have 10 seconds to open it before the lock activates again. Softly press and then open the Lid.
3. Turn off the printer.
4. Clean the Print chamber if needed.
5. Unscrew both screws on the Recoater cover and take off it.
6. Freely move the Recoater to the Feed Bed side.
7. Unscrew the screws on the Recoater cord mounting plate with spring (Overflow Bin side).
8. Freely move the Recoater to the Overflow Bin side.
9. Unscrew the screws on the other side of the cord (Feed Bed side).
10. Place the Recoater in the space between the Beds.
11. Remove the Recoater cord from both sockets.
12. Take the cords off the Recoater bearing system.
13. Take the left ending of the cord and gently reeve, first the mounting plate, then the ending, through the gap between the rotary shaft and Recoater housing to the right side.
14. Use a clean cloth to wipe the Recoater rotary shaft. Rotate the roll during the cleaning.
15. Take the new Recoater cord.
16. Put the new cord through the Recoater slide shaft and then onto the Recoater bearing system. It should go under the black bearings and over the roll bar.



17. Check if anything is blocking the slide of the cord.
18. First, mount the end of the cord with the spring on it.
19. Slide the Recoater to the Feed Bed side.
20. Mount the cord starting from the side of the Overflow Bin gap. Be sure that the spring is fitted into the hole behind the plate.
21. Screw and tighten up the screws.
22. Pull the cord to tense the spring.
23. Slide the Recoater to the Overflow Bin side.
24. Mount the cord using screws on the opposite side.
25. Move the Recoater and check if the rotary shaft is rolling properly.
26. Assemble the Recoater cover and screw both screws on the Recoater cover.
27. Turn the printer (use Ignition key).
28. On the touchscreen press CONTROL PANEL//MOTORS//HOME ALL AXES.
29. Check if Recoater moving without any disturbance. Properly installed cord is moving slightly right and left on the bearing system.

17. Packaging guide for Lisa PRO Printer

A. PREPARING LISA PRO PRINTER TO BE PACKED

1. Turn on the printer and wait until the main menu is loaded.
2. Unlock the printer's Lid: press UNLOCK LID/OVERFLOW BIN button on the screen. Remember, you only have 10 seconds to open it before the lock activates again. Open the Lid.
3. Turn off the printer for cleaning.
4. Clean the printer from the powder (both BEDs and the space around them, OVERFLOW BIN, RECO-ATER).
5. Open the Heating module and remove the Laser Protective Glass. Put it in the original box (STARTUP BOX). Secure it with tape for transportation.
6. Put on the original plastic protection cap on the Laser system and mount the Heating module back to the printer's Lid.
7. Check that the BEDs are at level with the printer housing and the RECOATER is located between the BEDs.
8. Close the printer's Lid.
9. Unplug the Power cable and put it in the STARTUP BOX.
10. Put the Ignition key to the STARTUP BOX.
11. Close and tape the STARTUP BOX. Place it in the service area under BEDs.
12. Unplug the Nitrogen hose from the Nitrogen inlet pipe.
13. Dismantle the Removable Front Panel.
 - Grasp the panel in the middle of its top and bottom edge. Pull the bottom edge firmly while holding to the top edge.
 - Disconnect all four Magnetic fasteners between the panel and the printer front side.
 - Hide the Removable Front Panel in the recess under the Flightcase lid.

B. PACKAGING LISA PRO PRINTER TO FLIGHTCASE

1. While holding the holders in the printer set the device on the bottom of the Flightcase (two people needed). The stickers on the bottom of the Flightcase will help you to position the printer correctly. If there are no labels, note the positioning of filler foams, especially the L-shaped foam.

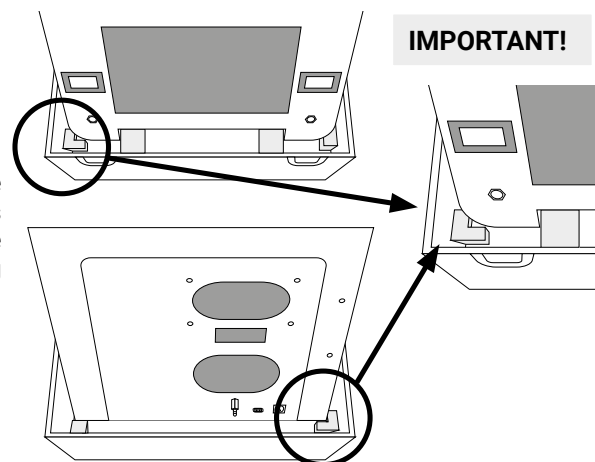

1. By holding the four handles of the the Flightcase cover, put it on the printer (two people needed).
2. Match the cover with the bottom of the Flightcase. Look at the colours of the markings on the sides of the cover and the bottom of the Flightcase (blue and red stickers).
3. Close the the Flightcase with 4 cover locks.
4. Place the Flightcase on the transport pallet, secure with foil and tape.



18. General legal information

Where this manual refers to Sinterit or the Company, this means Sinterit sp. z o.o. with its legal seat in Krakow, registered by the District Court for Kraków-Śródmieście in Krakow, XI Commercial Division of the National Court Register under number: 535095, NIP (tax number): 6793106416, with the share capital for a date of publication of this manual of PLN 102,050 (say: one hundred and two thousand and fifty).

This document contains material protected under copyright and industrial property laws. This means that the document may not be, including but not limited to, reproduced or modified without the consent of Sinterit.

This manual serves to assist in the correct use of the device, perform basic maintenance and, if necessary, to solve simple problems, allowing to maintain the device in a good condition.

This manual contains content exclusively for the provision of information and the use by individuals professionally trained and engaged in the operation and maintenance of the equipment described below.

The information contained in this document is intended for use only with the product made by Sinterit and called Sinterit Lisa PRO printer.

Due to the constant development of Sinterit's products the information contained in this manual, specifications and markings are subject to change without notice.

19. Disclaimer

Sinterit is not responsible for any use of this information in relation to other products.

Although every effort has been taken to provide accurate information about the product, Sinterit assumes no responsibility for any incorrect information or omission. Sinterit reserves the right to correct any errors and disclaims any liability in situations resulting from these errors.

Sinterit shall not be liable for defects in the printer's firmware.

Further limitations or exclusions of Sinterit's liability may result from the applicable laws or agreements entered into with the buyer of the products.

20. Trademarks

Sinterit logo is a registered trademark of the Company.

21. Software license agreement

Sinterit grants the buyer a non-transferable license without a right to sublicensing to use the control software Sinterit STUDIO under the terms and conditions set forth in an agreement between the buyer of Sinterit Lisa PRO Printer and the Company.



22. Terms of warranty

The terms of the warranty are set forth in the agreement between the buyer and the Company.

In case of a purchase made in the Sinterit online shop, the terms of the guarantee are specified in the Terms and Conditions, subject to the acceptance of the Customer before placing an order.

In case of purchases made outside the Sinterit online store, the warranty terms may be specified in the offer, or in another form chosen by the Company to provide the customer with relevant information before making a purchase decision. Unless otherwise stated in the documents referred above or specifically agreed, the Sinterit's warranty does not cover, including but not limited to:

- damages, abnormalities or malfunction caused by a client or any third party;
- damages, abnormalities or malfunction caused by inappropriate use, effects of force, insufficient or inappropriate maintenance, abnormal operating conditions, incorrect installation or inadequate servicing;
- damages, abnormalities or malfunction caused by dismantling, alterations, tuning or other changes of the product by a client or any third party made without the written consent of Sinterit;
- damages, abnormalities or malfunction caused by or related to use of consumables other than those being supplied by Sinterit;
- damages, abnormalities or malfunction caused by or related to use of product against its intended use, instructions/ manuals or safety regulations;
- damages, abnormalities or malfunctions Sinterit is not liable for, according to the applicable law,
- damages exceeding the price paid by the client;
- normal wear and tear, including but not limited to replaceable Short Infrared heaters, Laser Protection Glass, Recoater cord, Recoater slide shaft, Recoater bearing system;
- damages, abnormalities or malfunction caused by the incompatibility of client software and Sinterit software or for any malware, or for non-fitness of software for a particular purpose;
- costs incurred by the client in connection with the conclusion of the product sale agreement as well as storage or insurance of products;
- damages of property caused by the defect of the product;
- loss of profits;
- incidental, indirect, special, consequential or punitive damages.

The warranty does not cover any cleaning of working parts.

The abovementioned exclusions of warranty apply as well to any other liability of Sinterit, to the widest extent permitted by the applicable law.

Terms of liability of sellers other than Sinterit such as distributors or resellers shall be regulated by them in separate documents.

23. Technical support

The latest information, technical support, and versions of the manual are available by contacting us through:

- e-mail: www.sinterit.com/support-page
- phone: +48 570 702 886

The list of distributors and technical support in specific countries can be found at www.sinterit.com/contact.

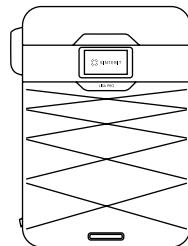
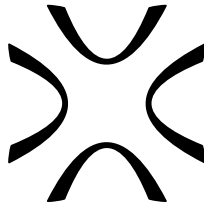

SINTERIT Sp.z o.o.
ul. Nad Drwina 10 bud. B3, 30-741 Krakow, Poland
www.sinterit.com
Contact: +48 570 967 854